

MDI. CHD. ZR. 4

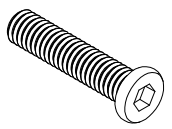

A x10
Spec: 5/16*L40

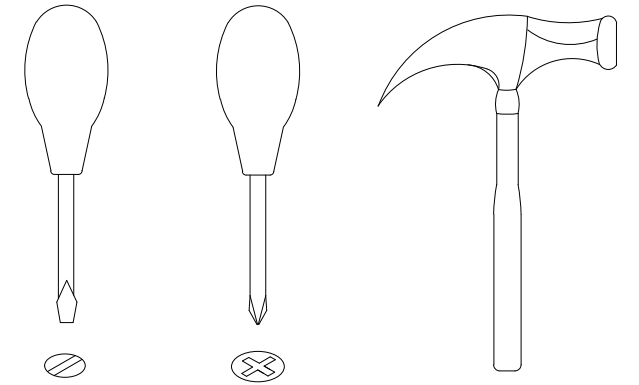
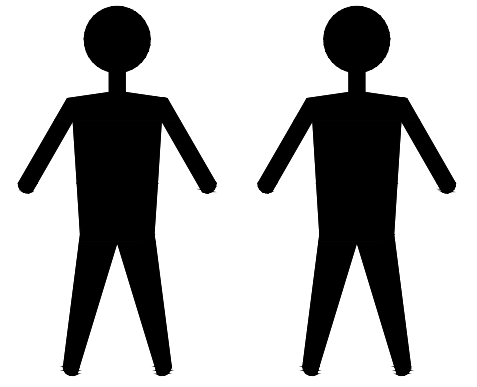
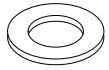

B x10
Spec: $\phi 8.2 * \phi 14$

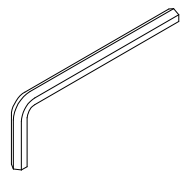

C x1
Spec: 5#

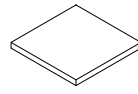

D x4
Spec: 40*40

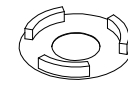

E x6
Spec:

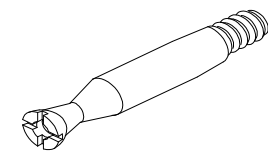

F x6
Spec: $\phi 7 * L48$

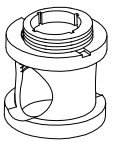

G x6
Spec: $\phi 15 * H15$

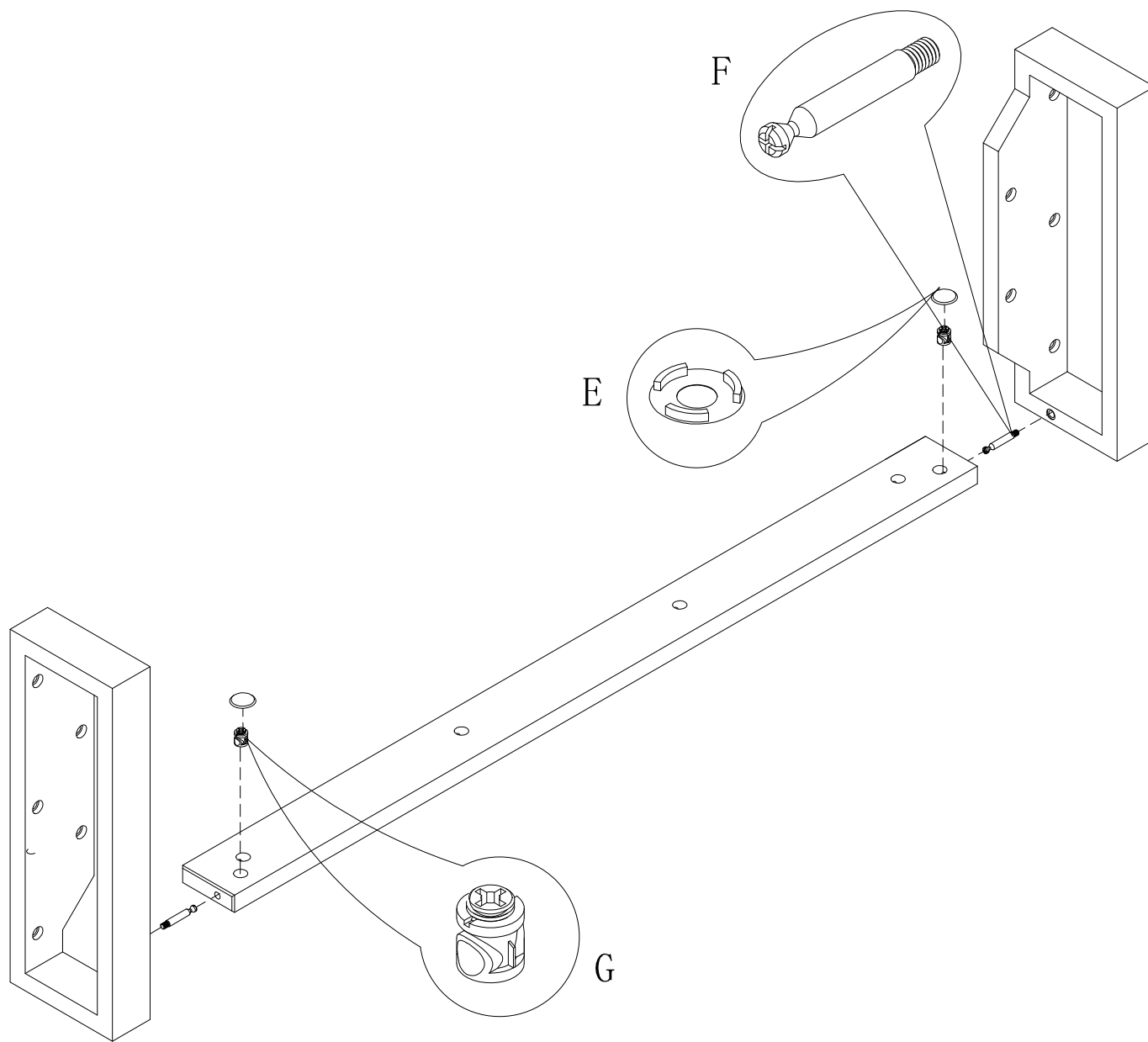

1

2

