

20.21.1707.00

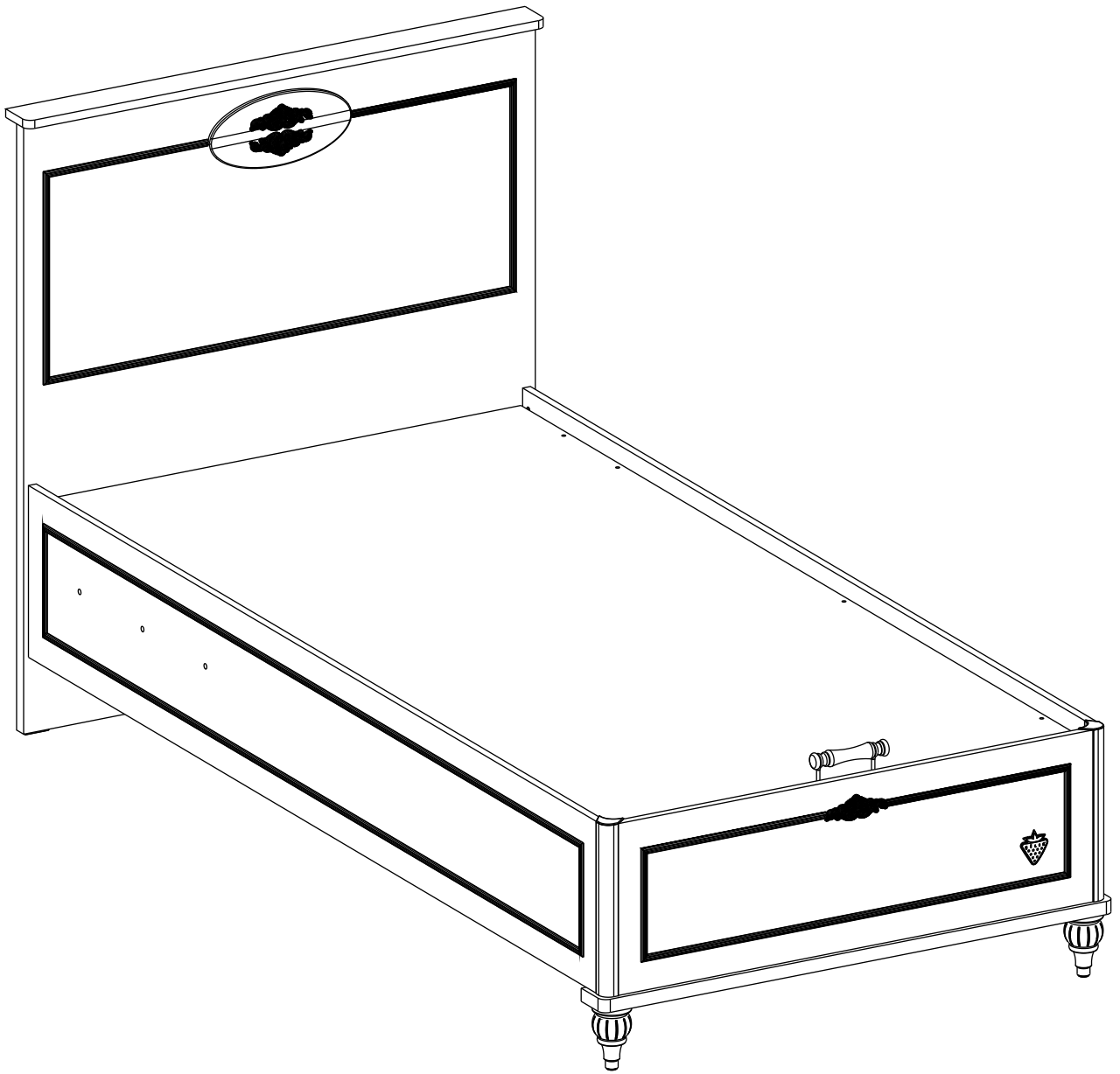

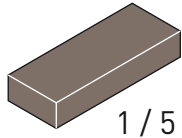

1 / 5

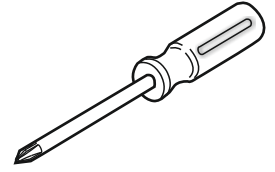
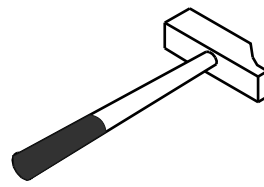
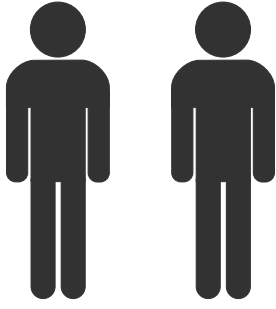
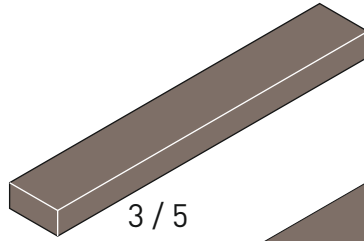

3 / 5

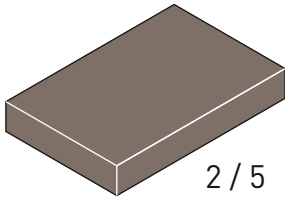

2 / 5

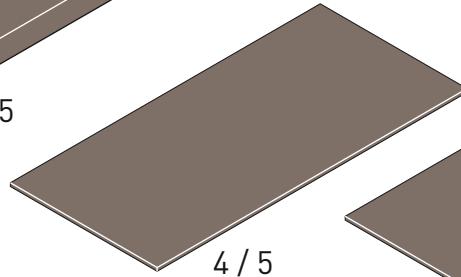

4 / 5

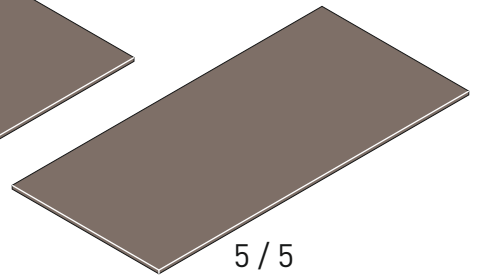

5 / 5

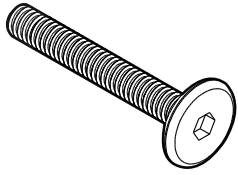

13.03.01.039 x 14
M6X55

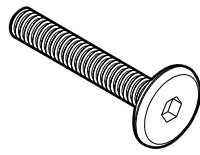

13.03.01.035 x 4
M6X40

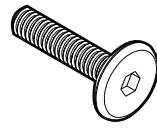

13.03.01.033 x 2
M6X35

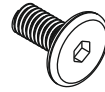

13.03.01.023 x 4
M6X15

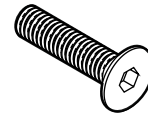

13.03.01.034 x 2
M6X35

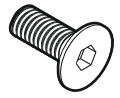

13.03.01.024 x 6
M6X15

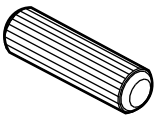

13.01.01.111 x 4

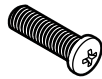

13.03.01.026 x 6
M6X20



13.03.01.021 x 12
M6X13



13.07.01.093 x 14



13.02.01.017 x 33



13.07.01.287 x 4

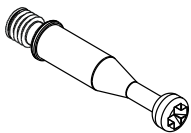

13.07.01.108 x 4



13.07.01.296 x 4



13.01.01.045 x 4

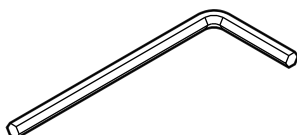

13.07.01.016 x 1

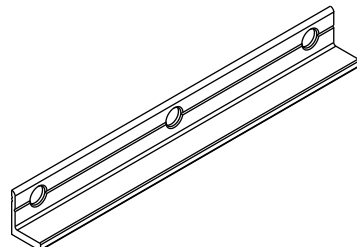

18.00.2000.208 x 1

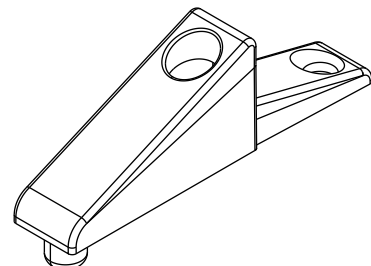

13.01.01.247 x 6

1/5

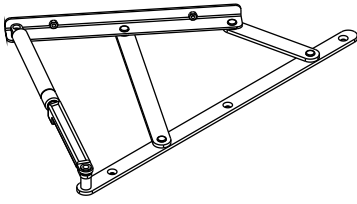

13.07.01.440 x 1

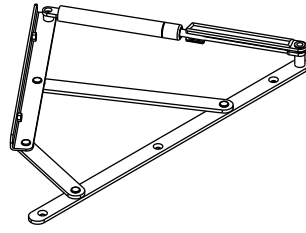

13.07.01.441 x 1

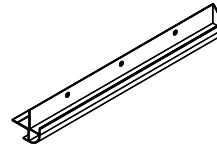

18.21.1707.206 x 2



13.01.01.293 x 2

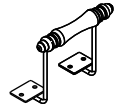

13.06.01.152 x 1

2/5

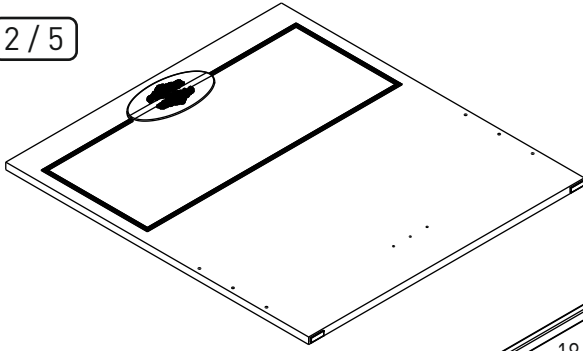

18.21.1707.001 x 1

18.21.1707.005 x 1

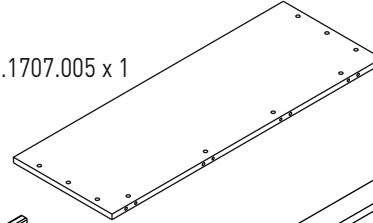

18.21.1707.006 x 1

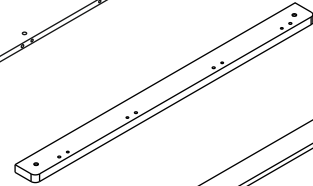

18.21.1707.002 x 1

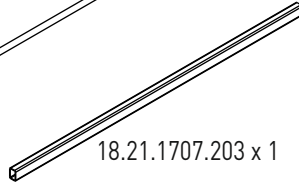

18.21.1707.203 x 1

3/5

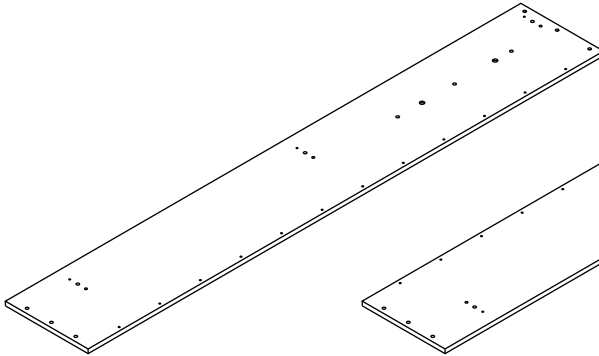

18.21.1707.003 x 1

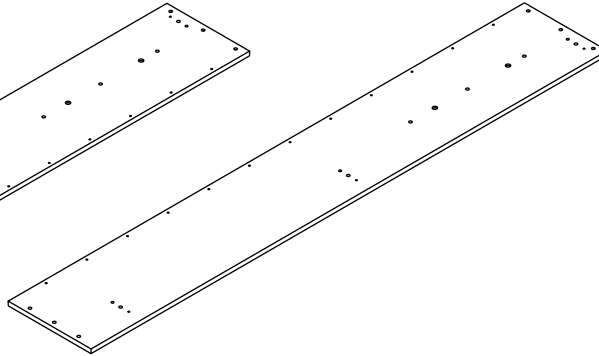

18.21.1707.004 x 1

4/5

18.21.1707.202 x 2

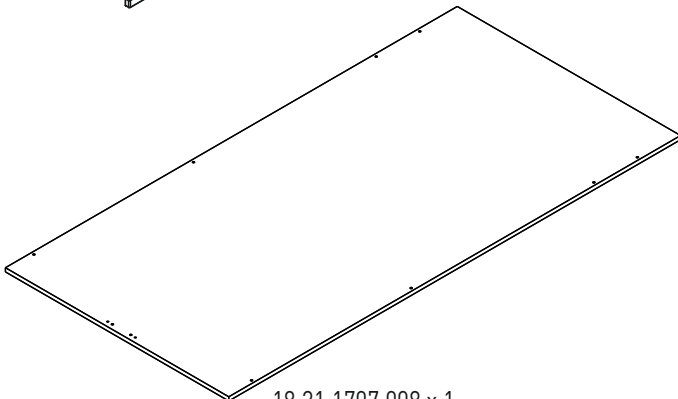
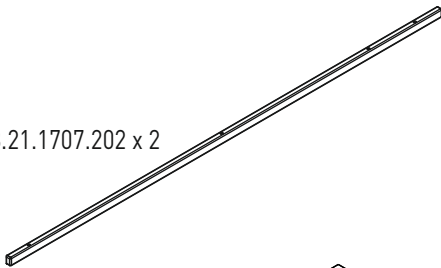

18.21.1707.008 x 1

5/5

18.00.2000.201 x 2

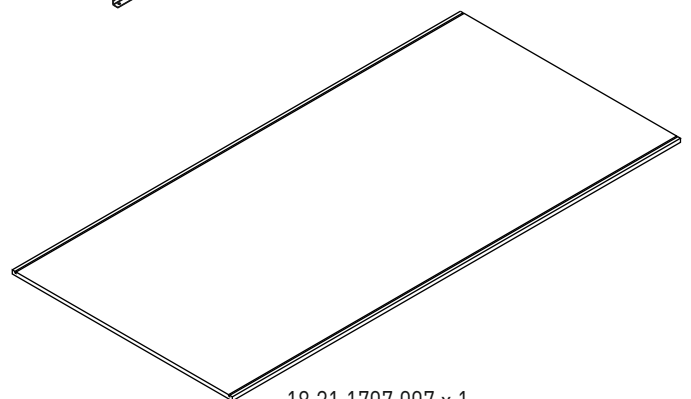
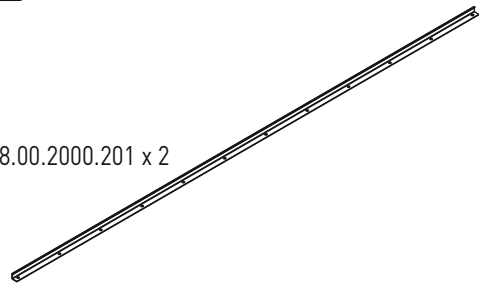

18.21.1707.007 x 1

1

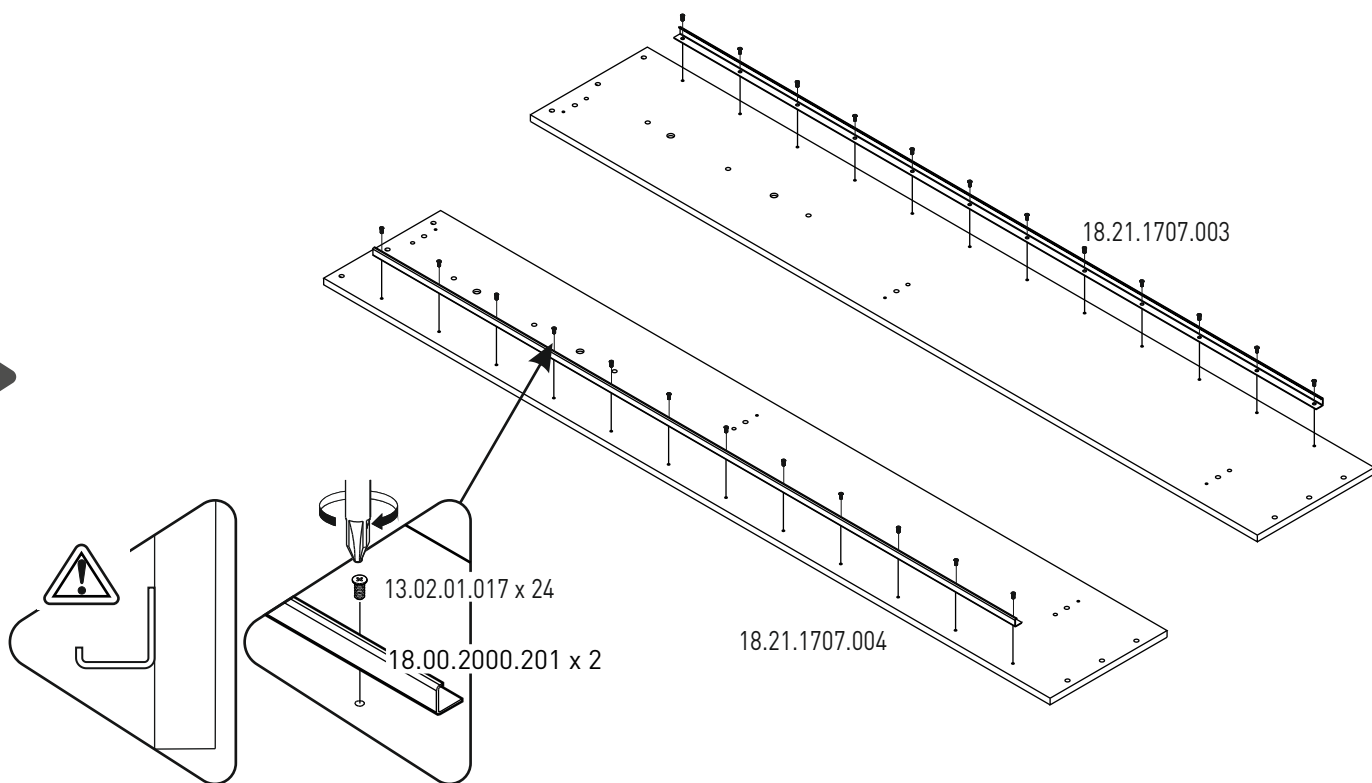

2

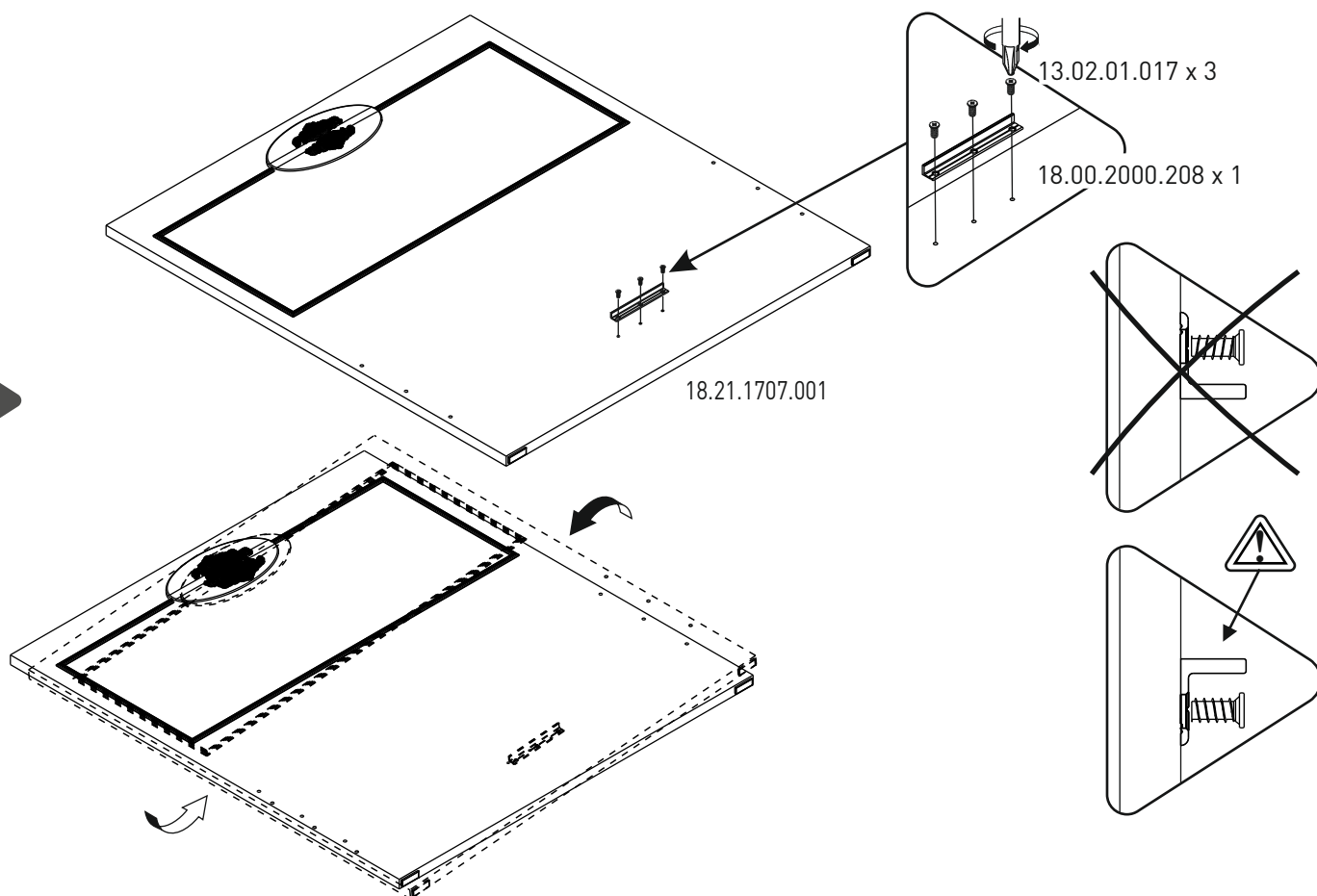

3

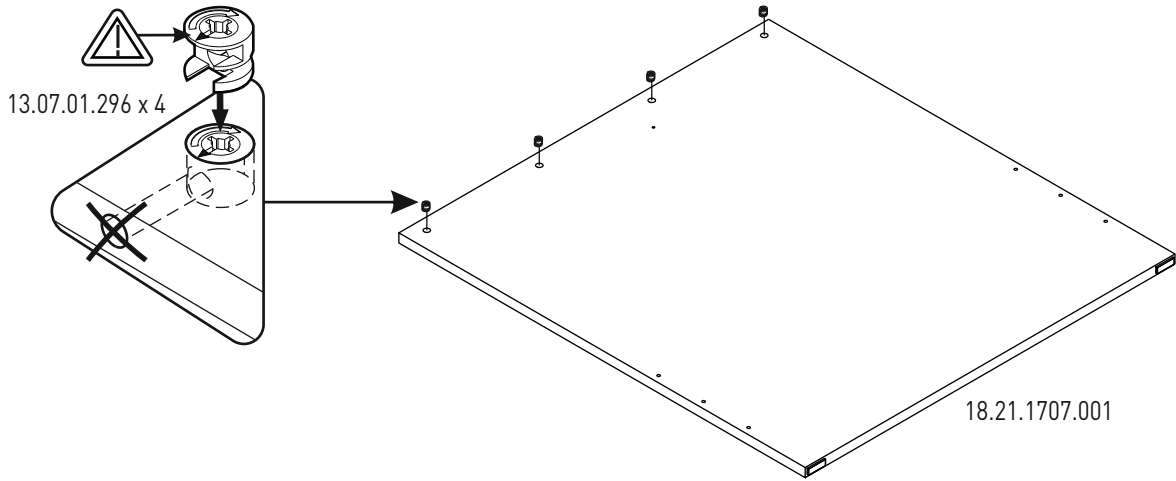

4

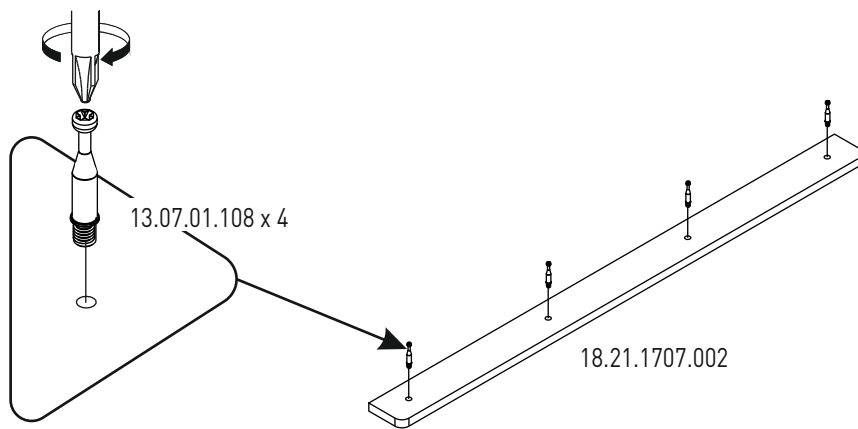

5

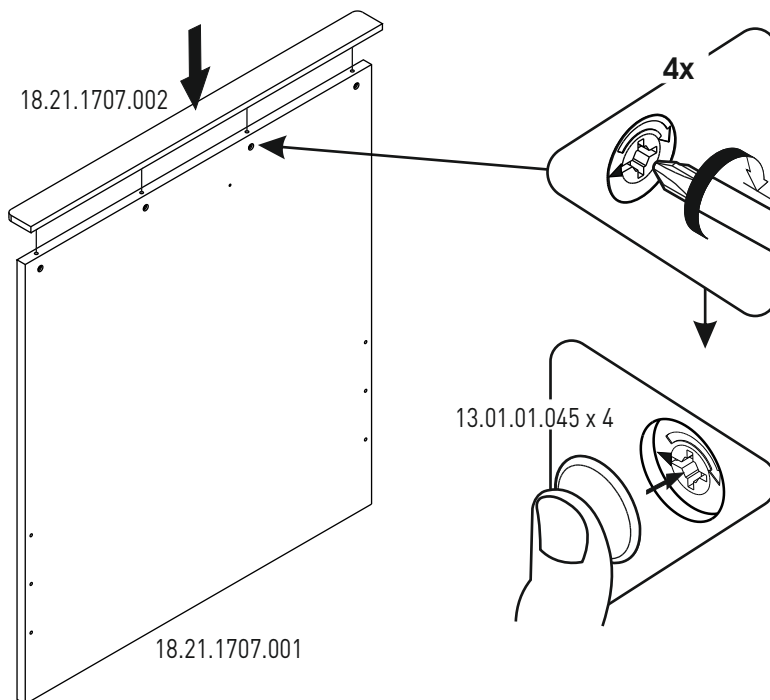

6

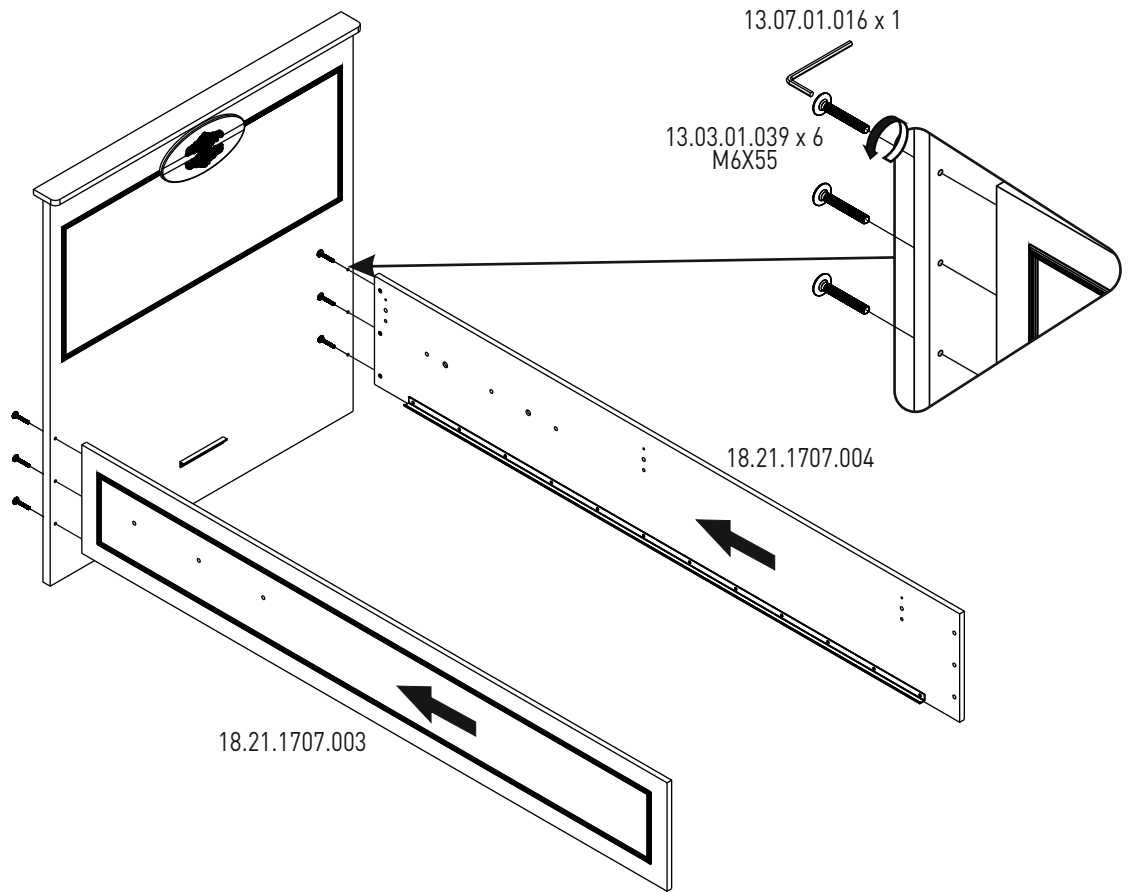

7

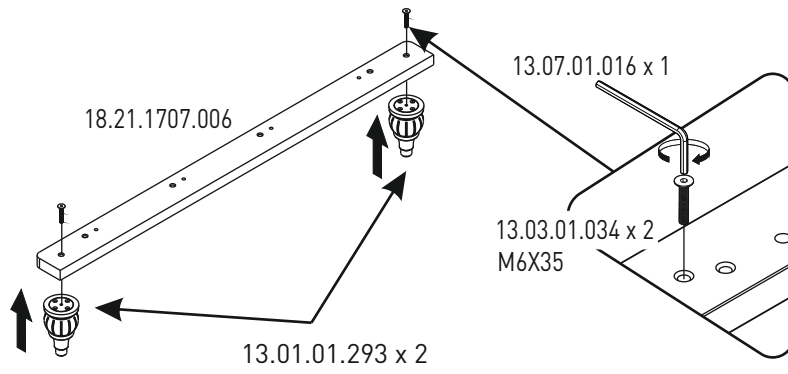

8

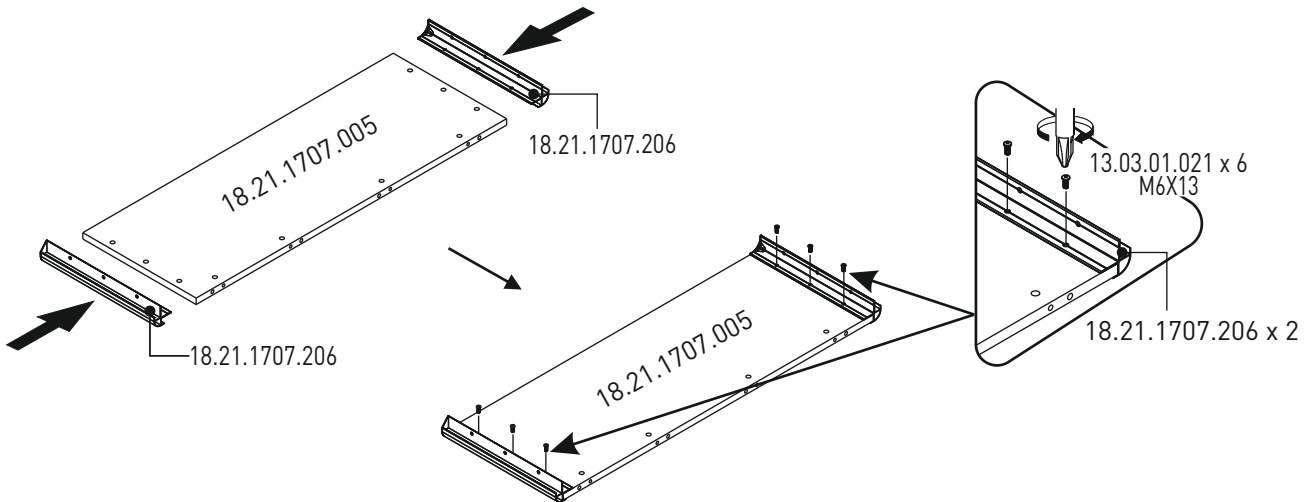

9

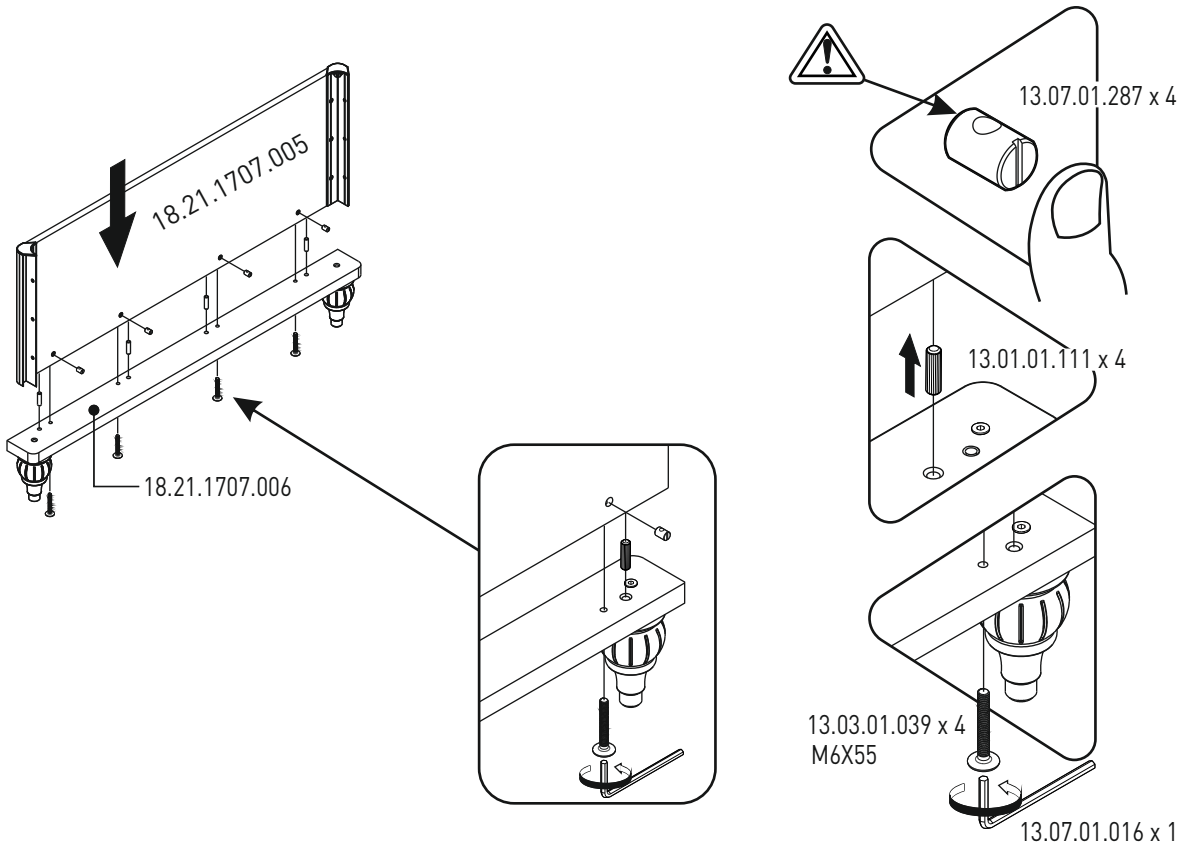

10

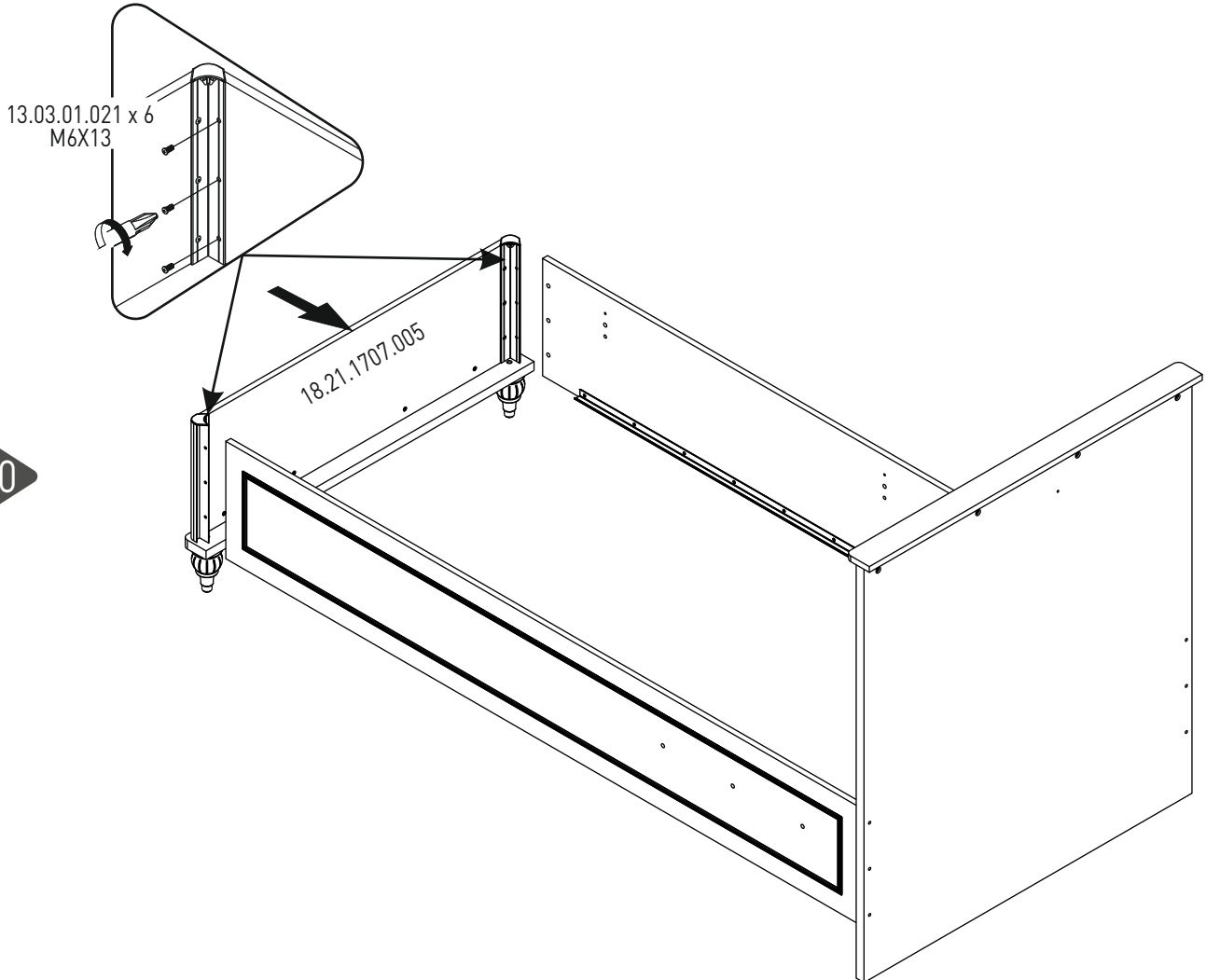

11

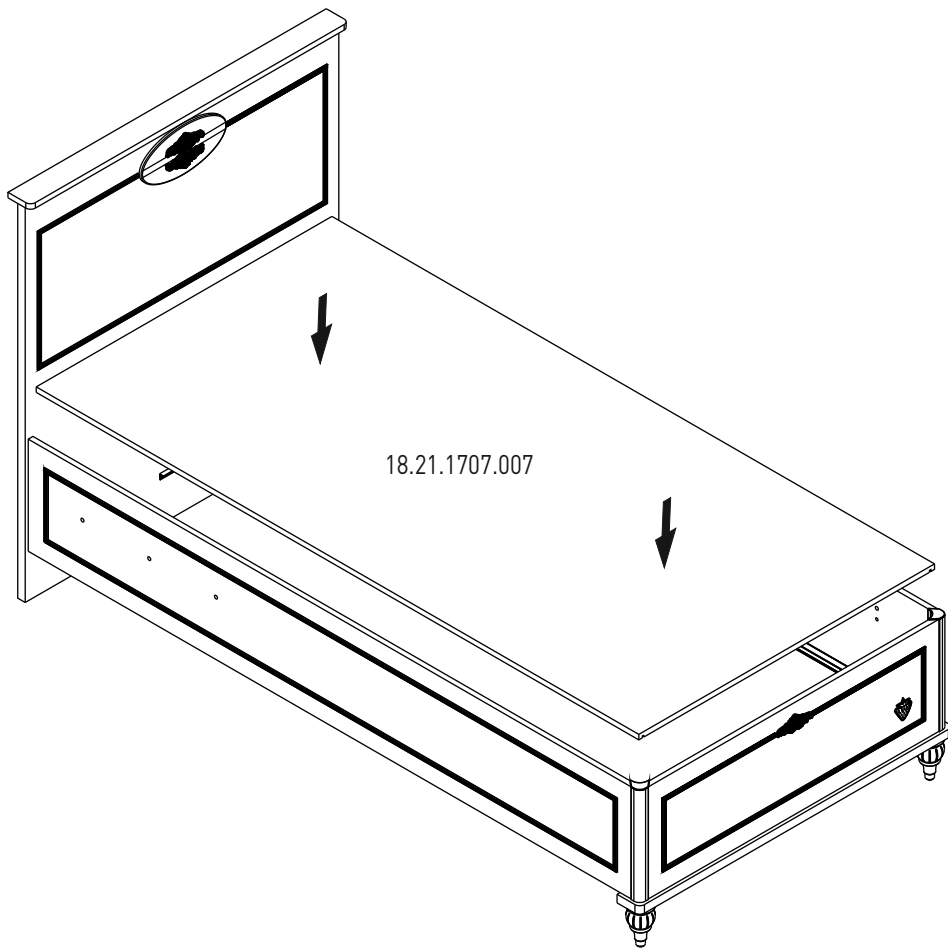

12

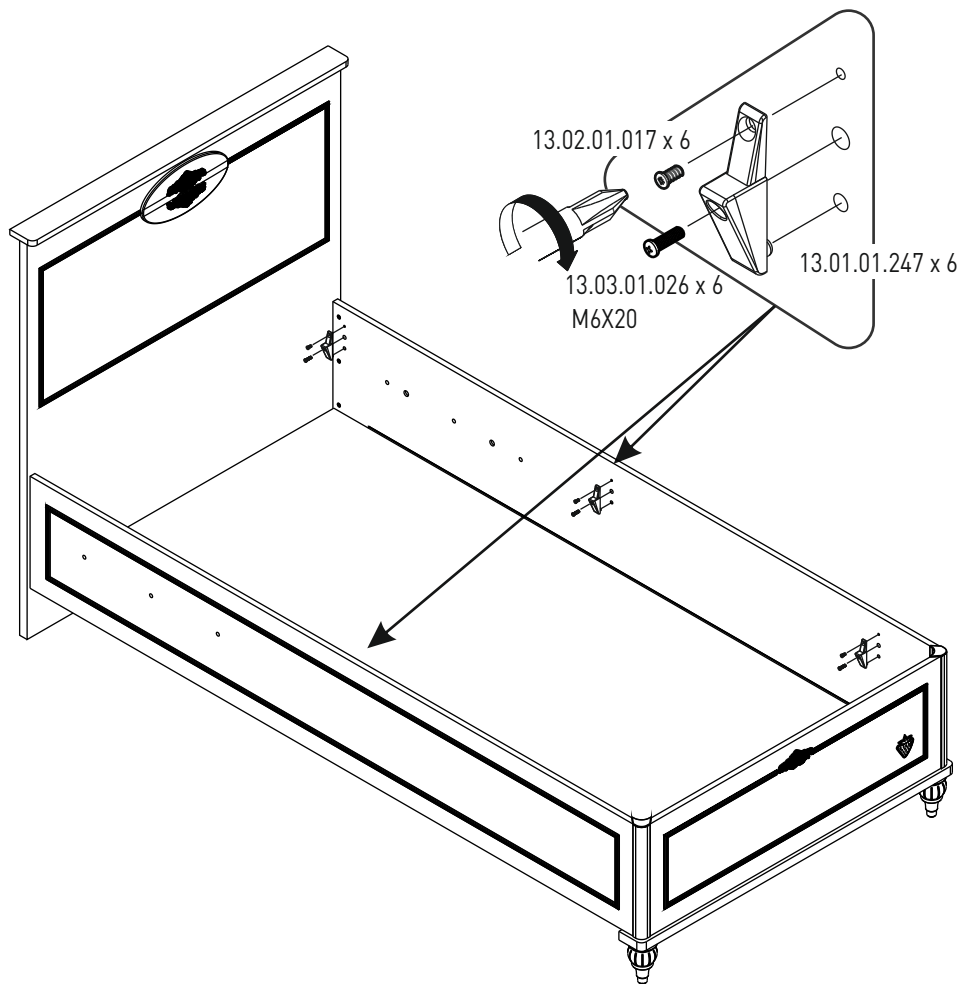

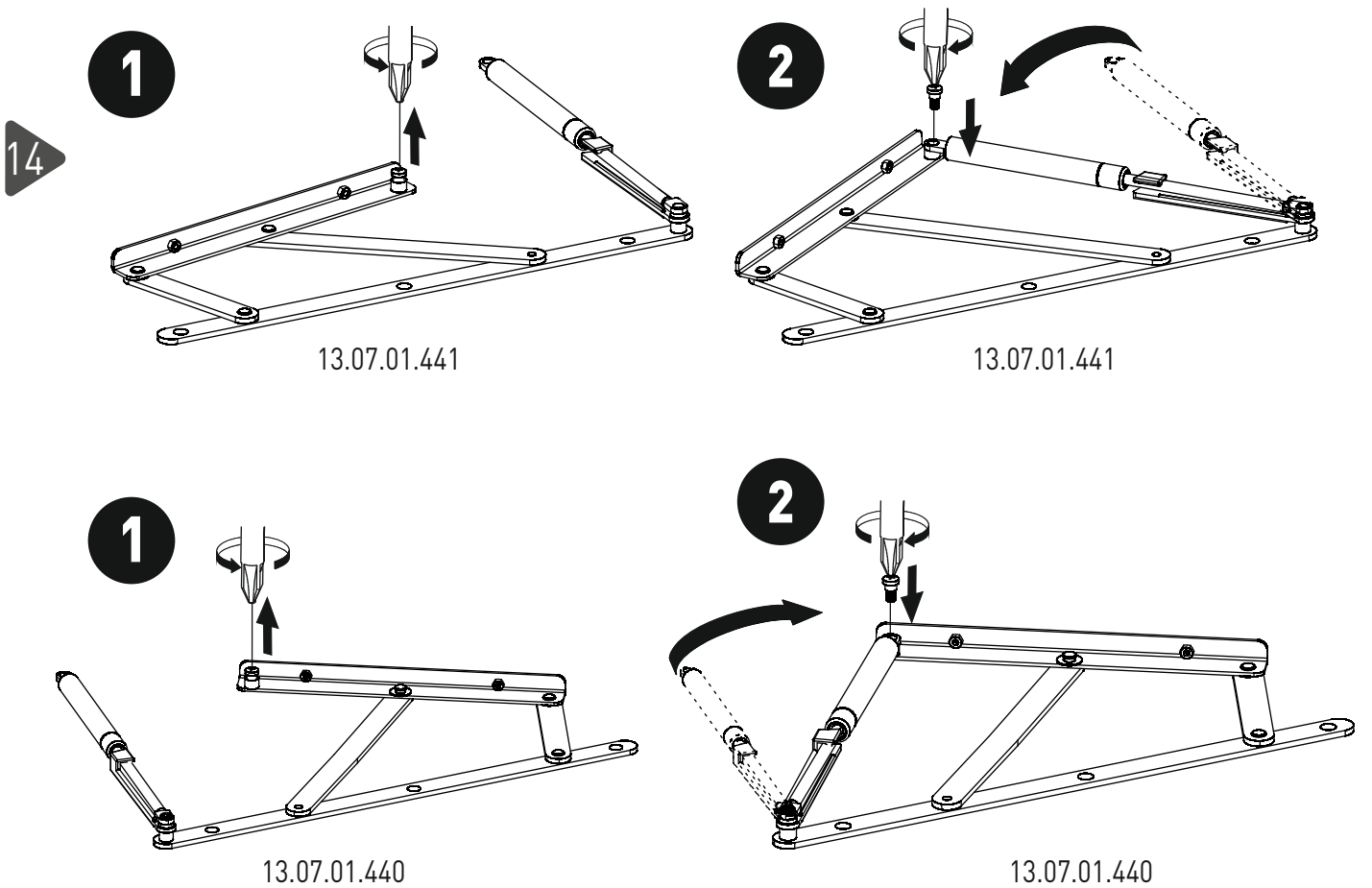
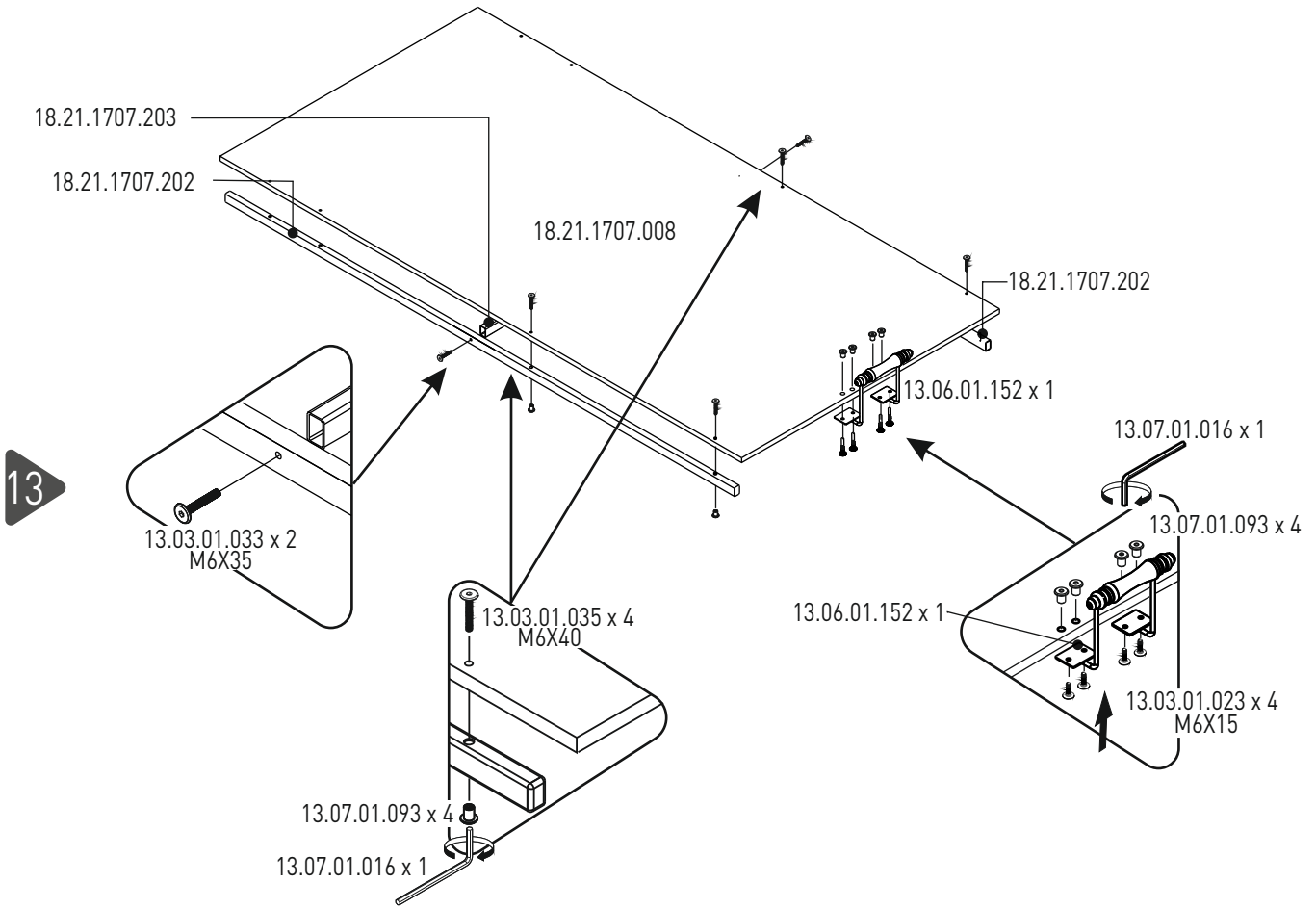

15

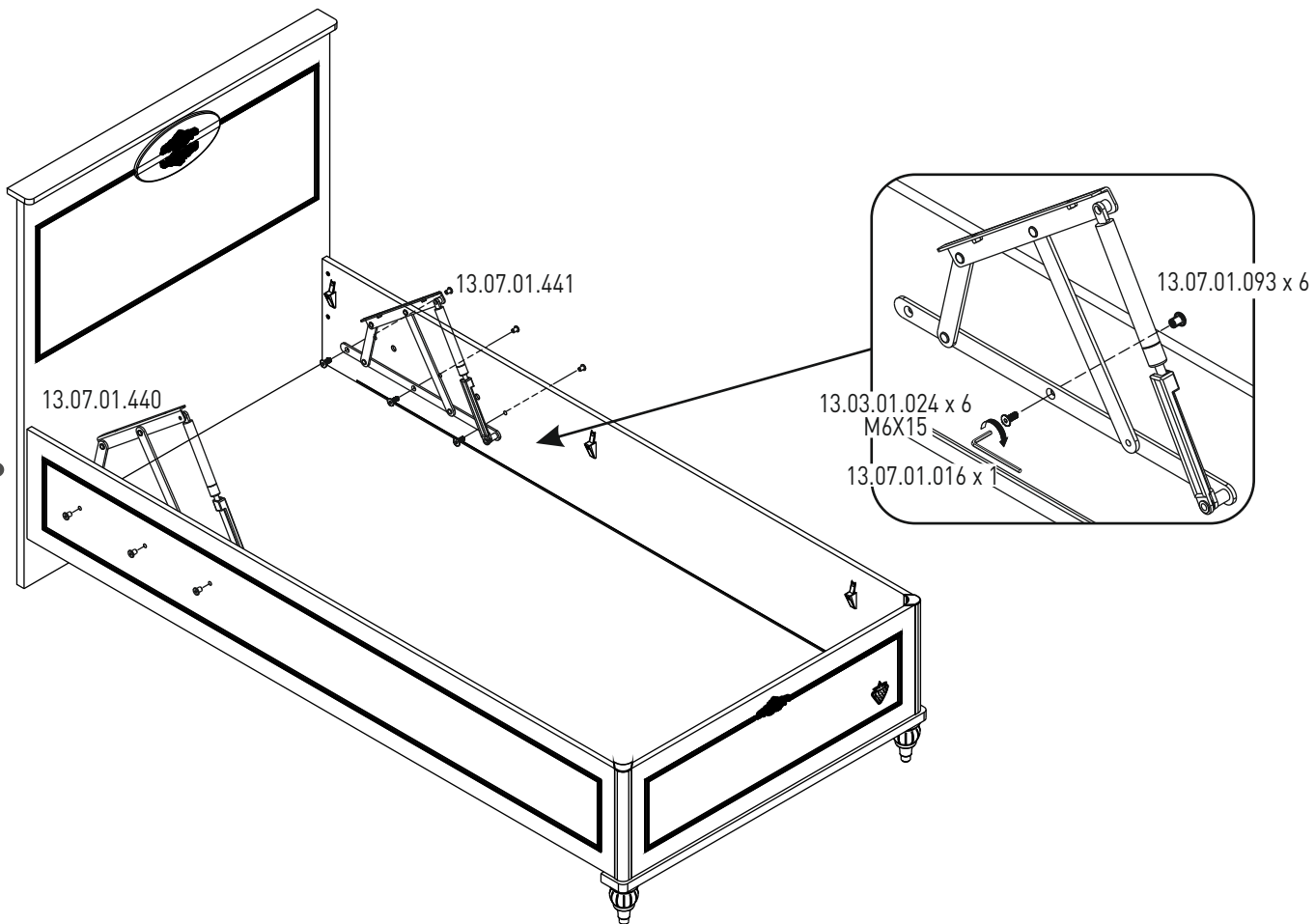

16

