

**20.00.1408.00**

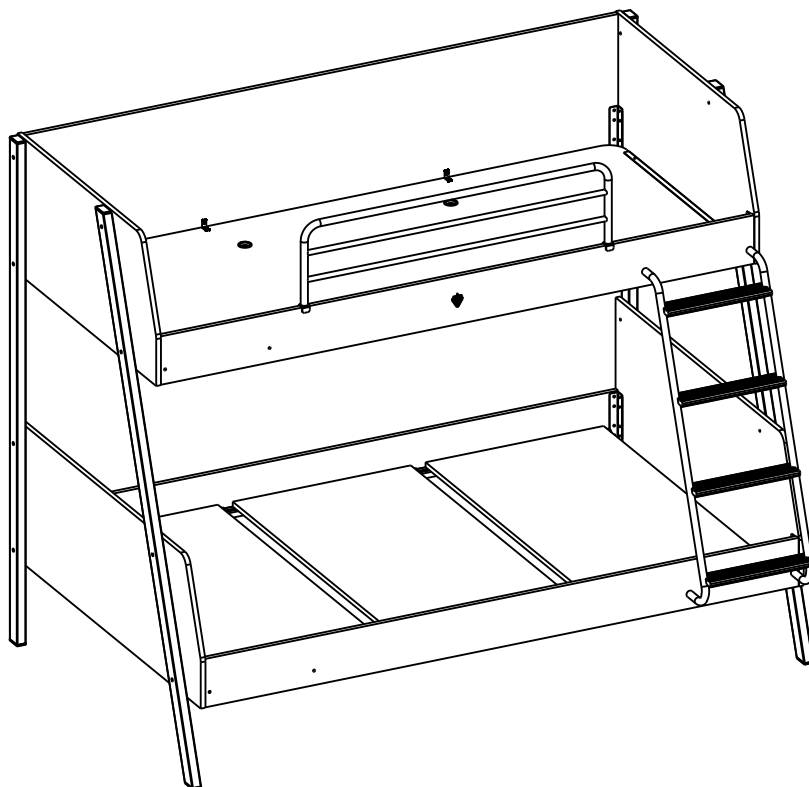

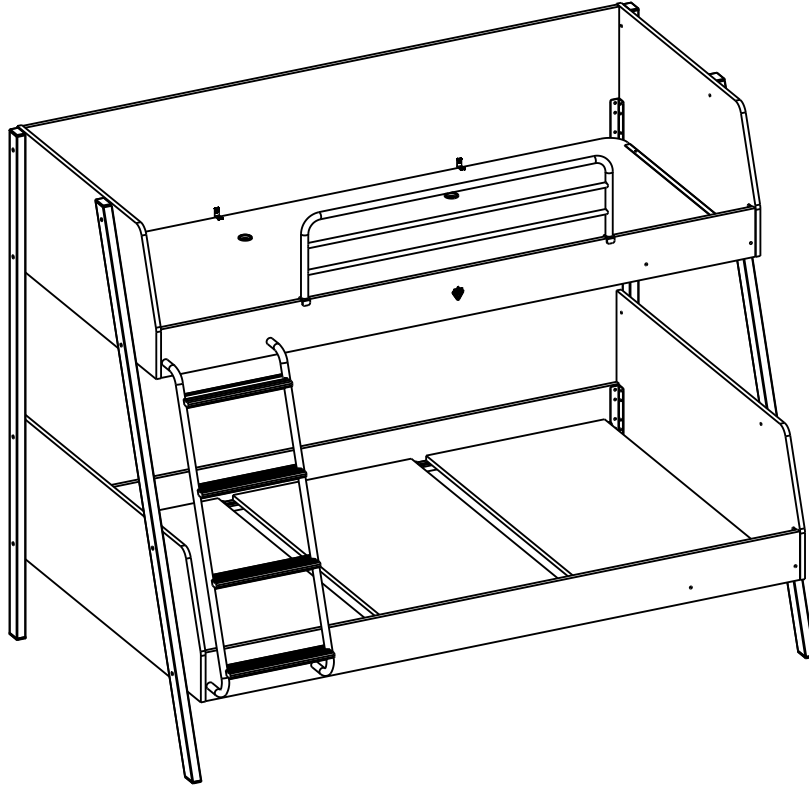

5 / 1

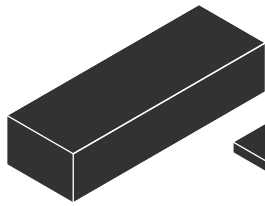
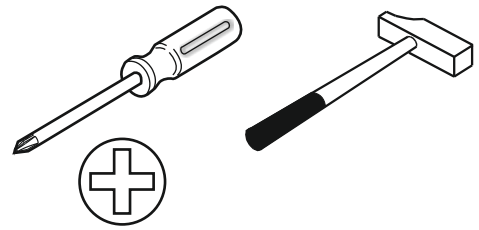
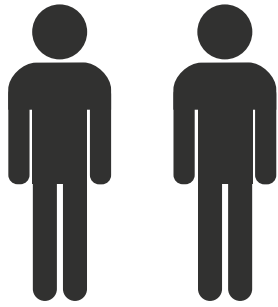
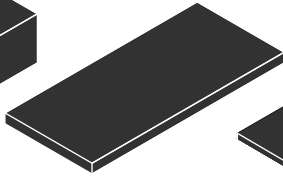

5 / 2

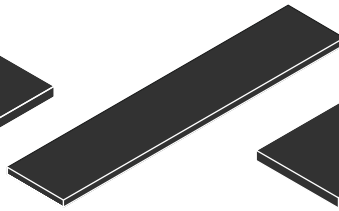

5 / 3

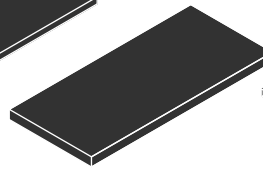

5 / 4

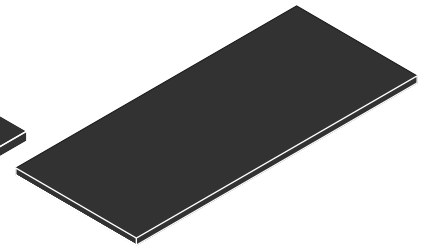

5 / 5



13.07.01.110 x 2

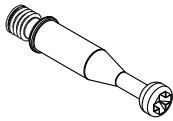

13.07.01.108 x 2

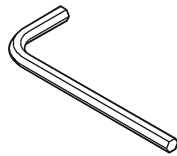

13.07.01.016 x 1



13.01.01.433 x 6

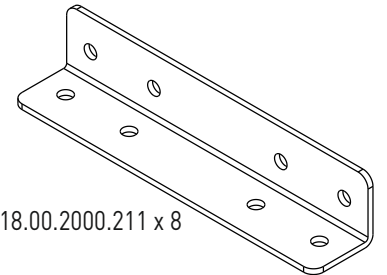

18.00.2000.211 x 8

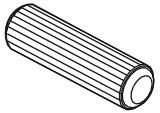

13.01.01.111 x 4



13.01.01.045 x 2



13.01.02.140 x 4

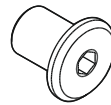

13.07.01.093 x 16



13.02.01.017 x 48

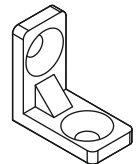

13.07.01.096 x 4

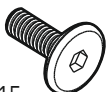

M6x15  
13.03.01.023 x 4

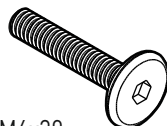

M6x30  
13.03.01.029 x 4

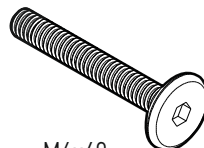

M6x40  
13.03.01.035 x 16



3,5X16  
13.02.01.001 x 4



M6X13  
13.03.01.021 x 62



M6X15  
13.03.01.024 x 4

5 / 1

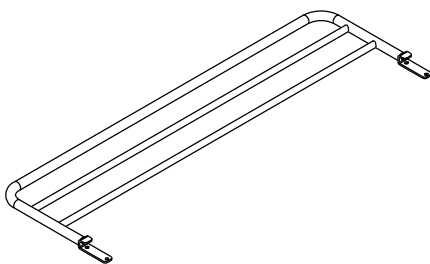

18.00.1408.206 x 1

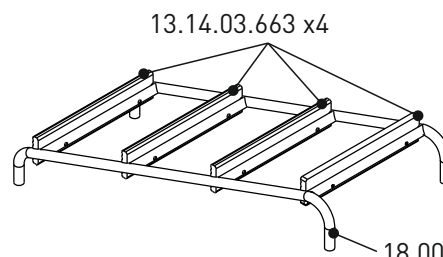

18.00.1408.012 x 1

13.14.03.663 x 4

18.00.1408.204

5/2

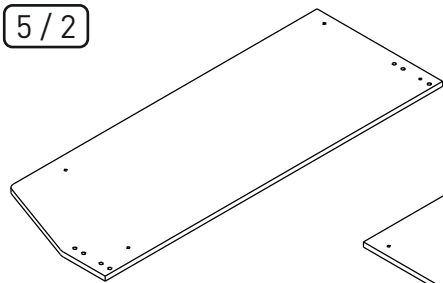

18.00.1408.001 x1

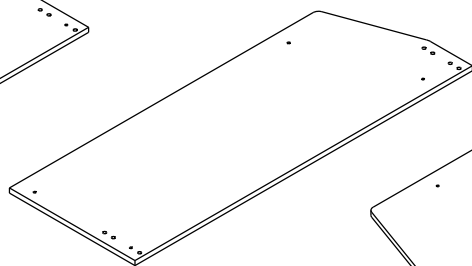

18.00.1408.002 x1

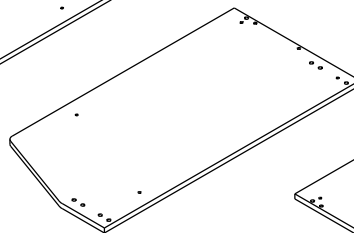

18.00.1408.006 x1

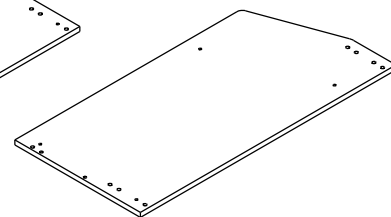

18.00.1408.007 x1

5/3

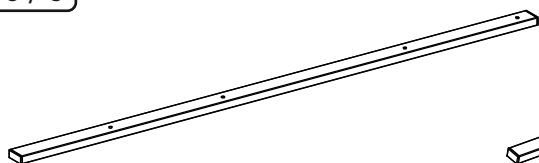

18.00.1408.201 x2

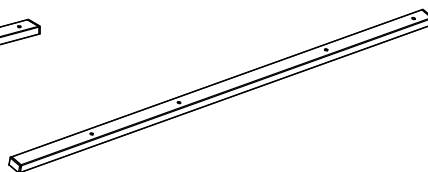

18.00.1408.202 x2

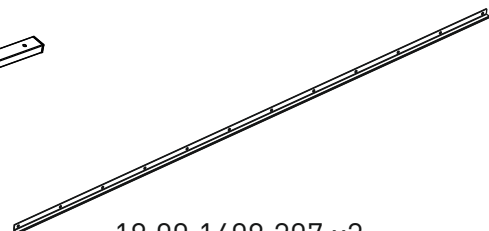

18.00.1408.207 x2

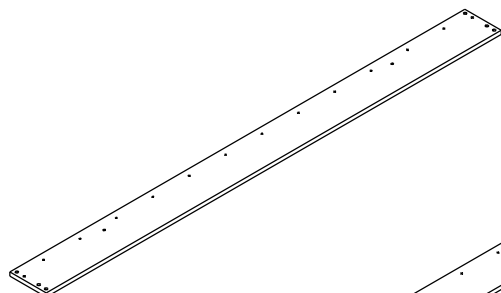

18.00.1408.004 x1

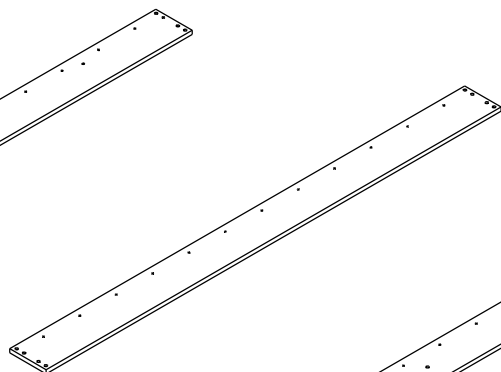

18.00.1408.003 x1

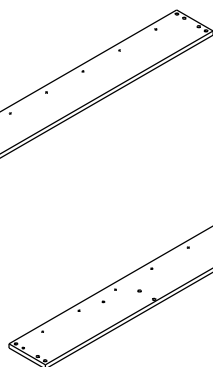

18.00.1408.005 x1

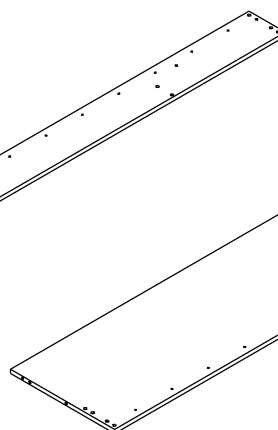

18.00.1408.008 x1

5/4

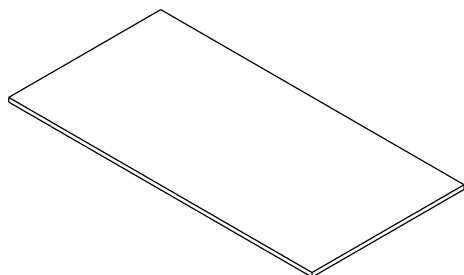

18.00.1408.009 x3

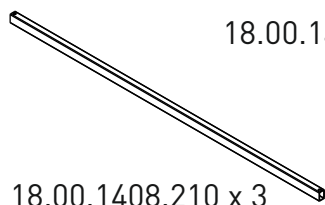

18.00.1408.210 x3

5/5

18.00.1408.207 x2

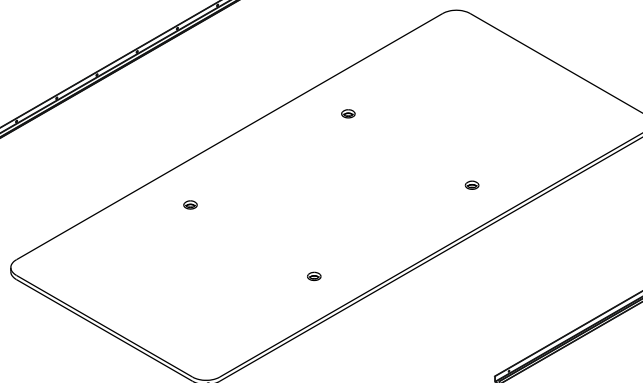
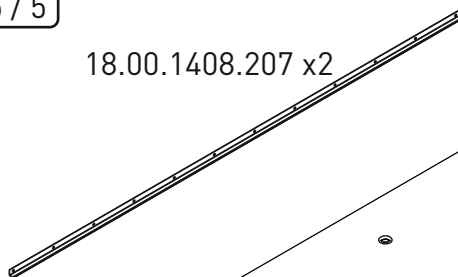

18.00.1408.010 x1



18.00.1408.208 x2

1

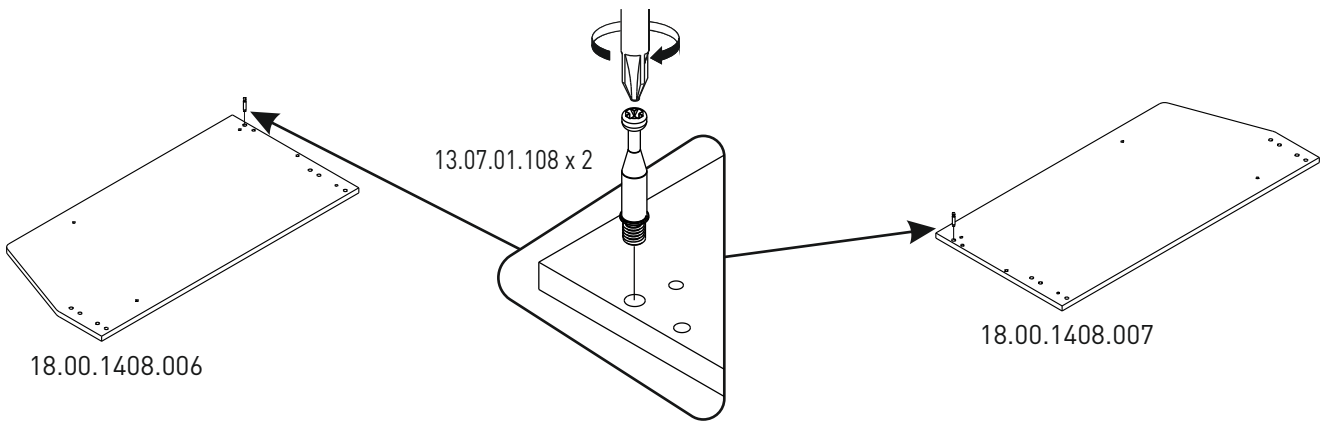

2

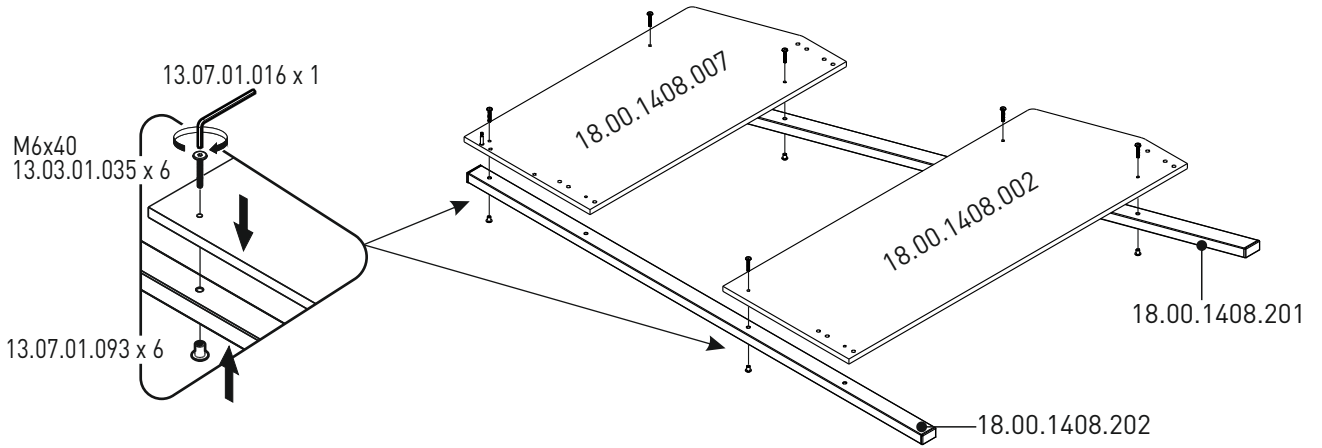

3

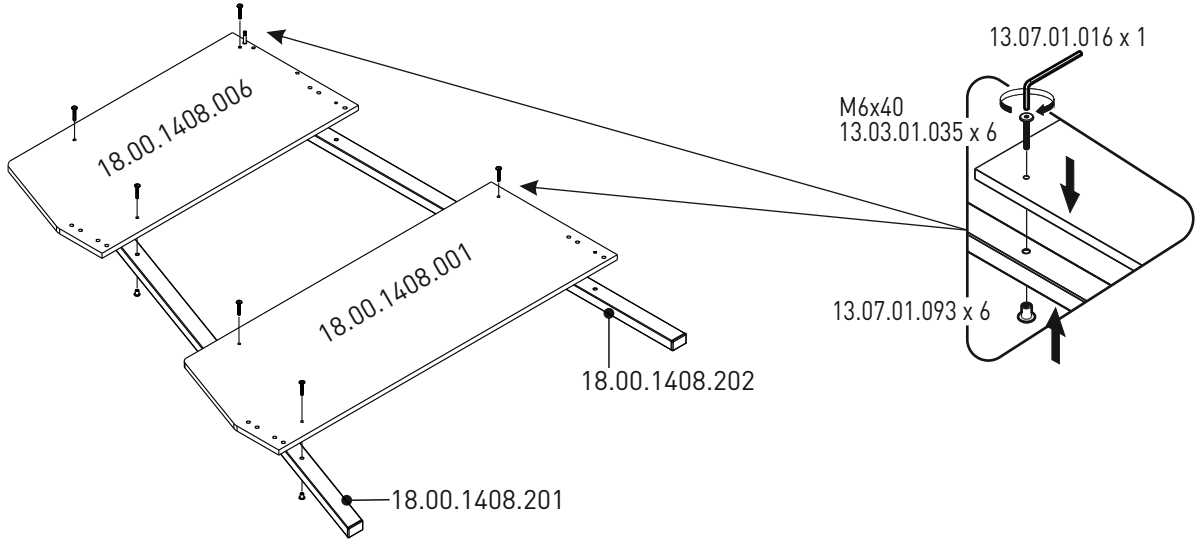

4

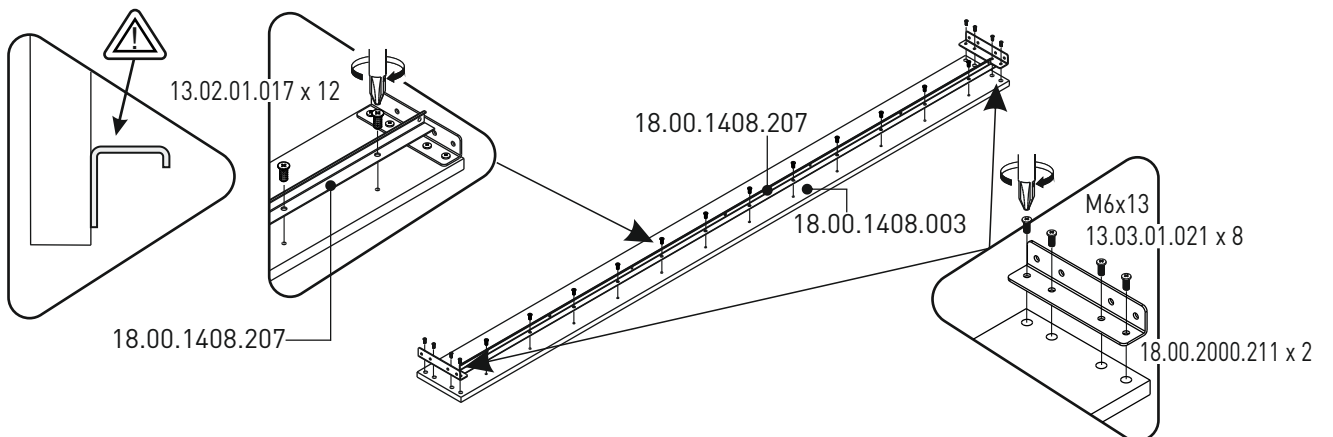

5

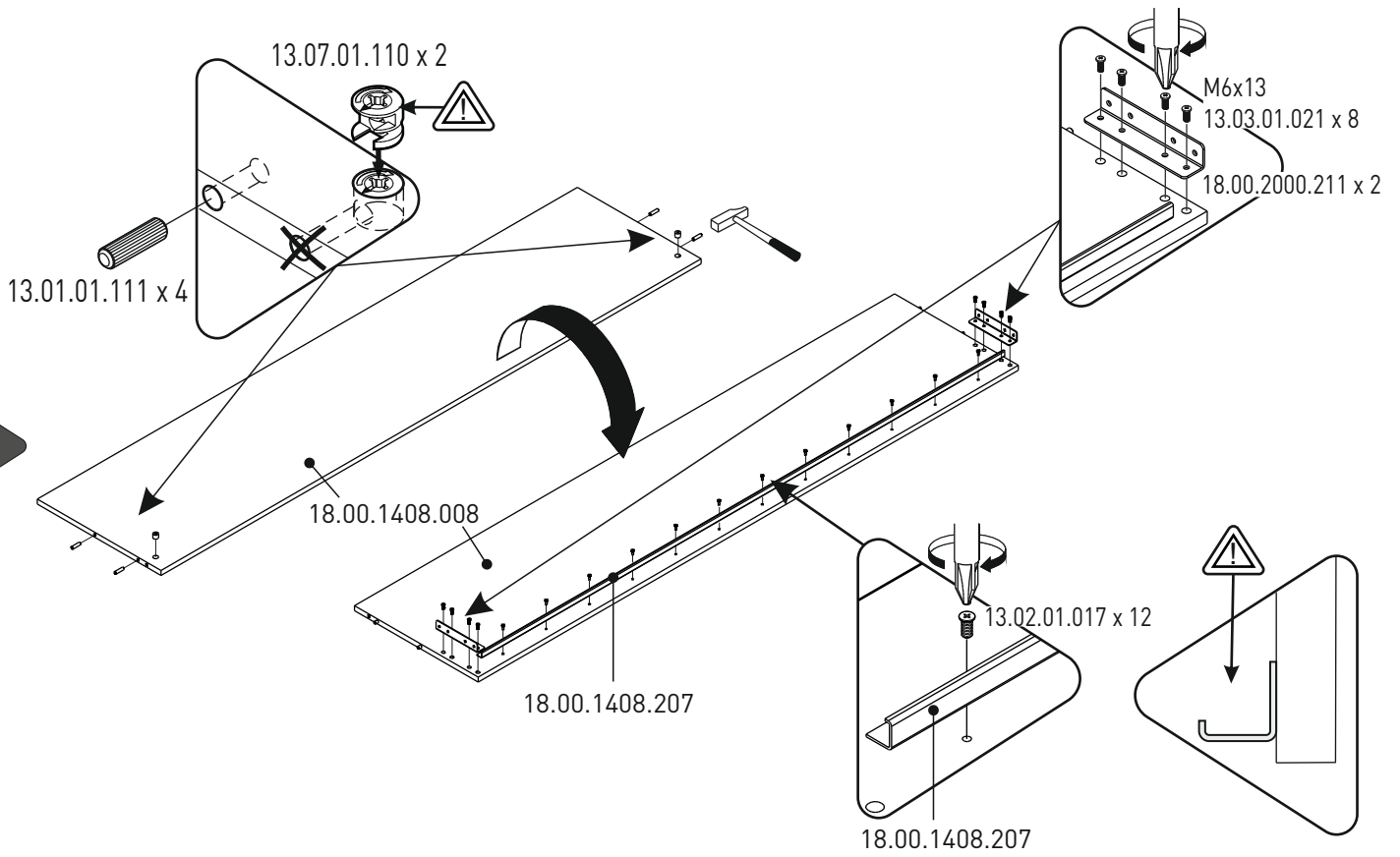

6

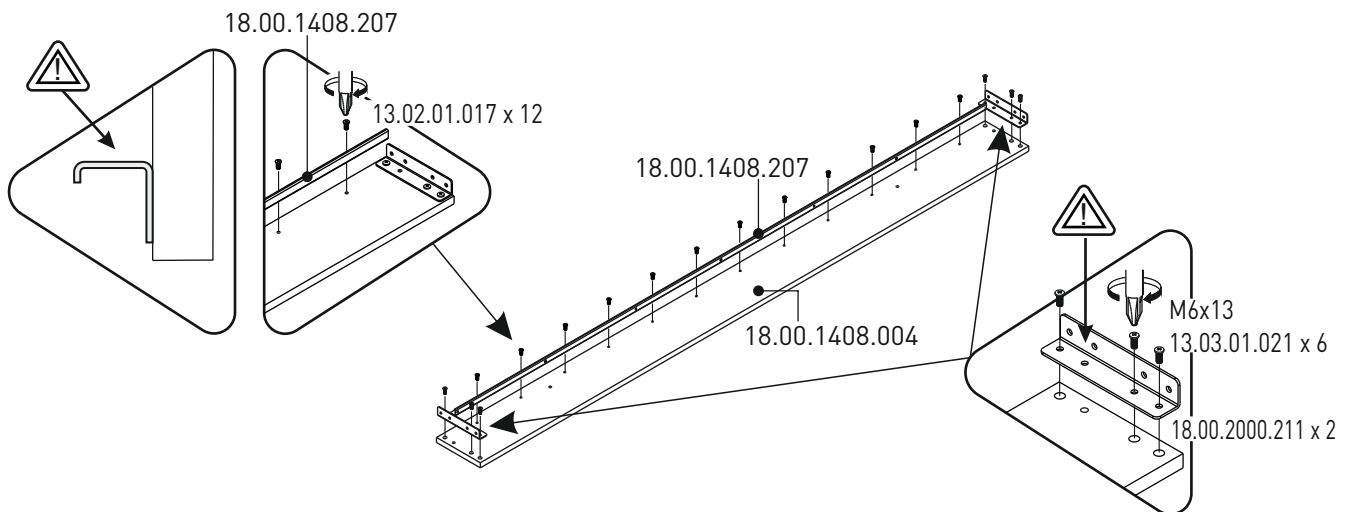

7

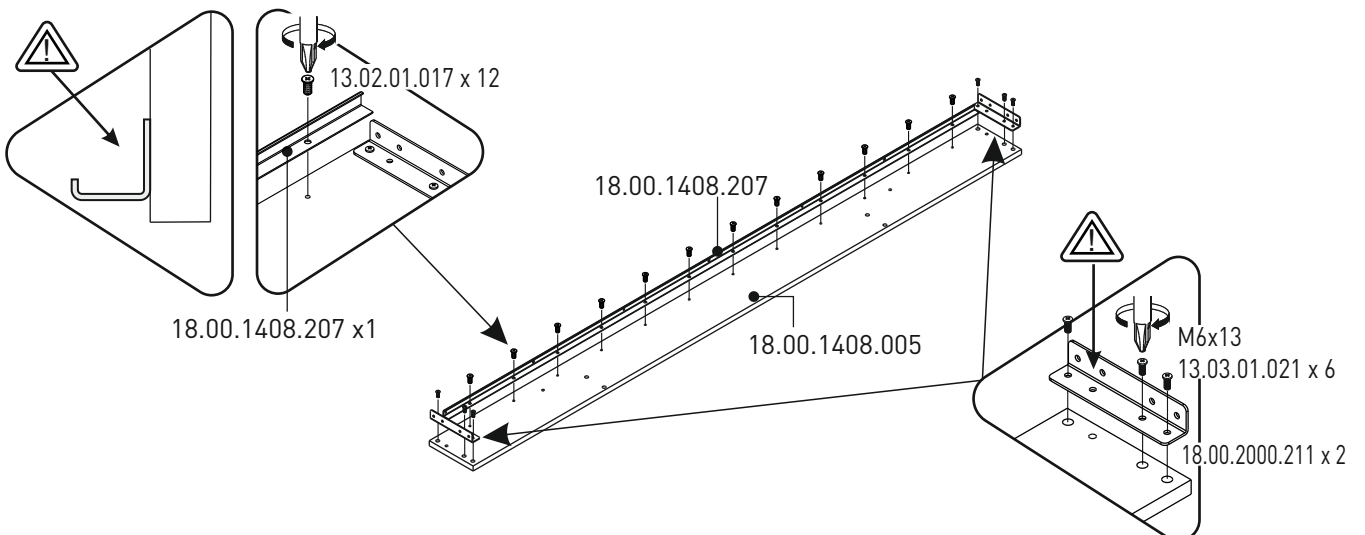

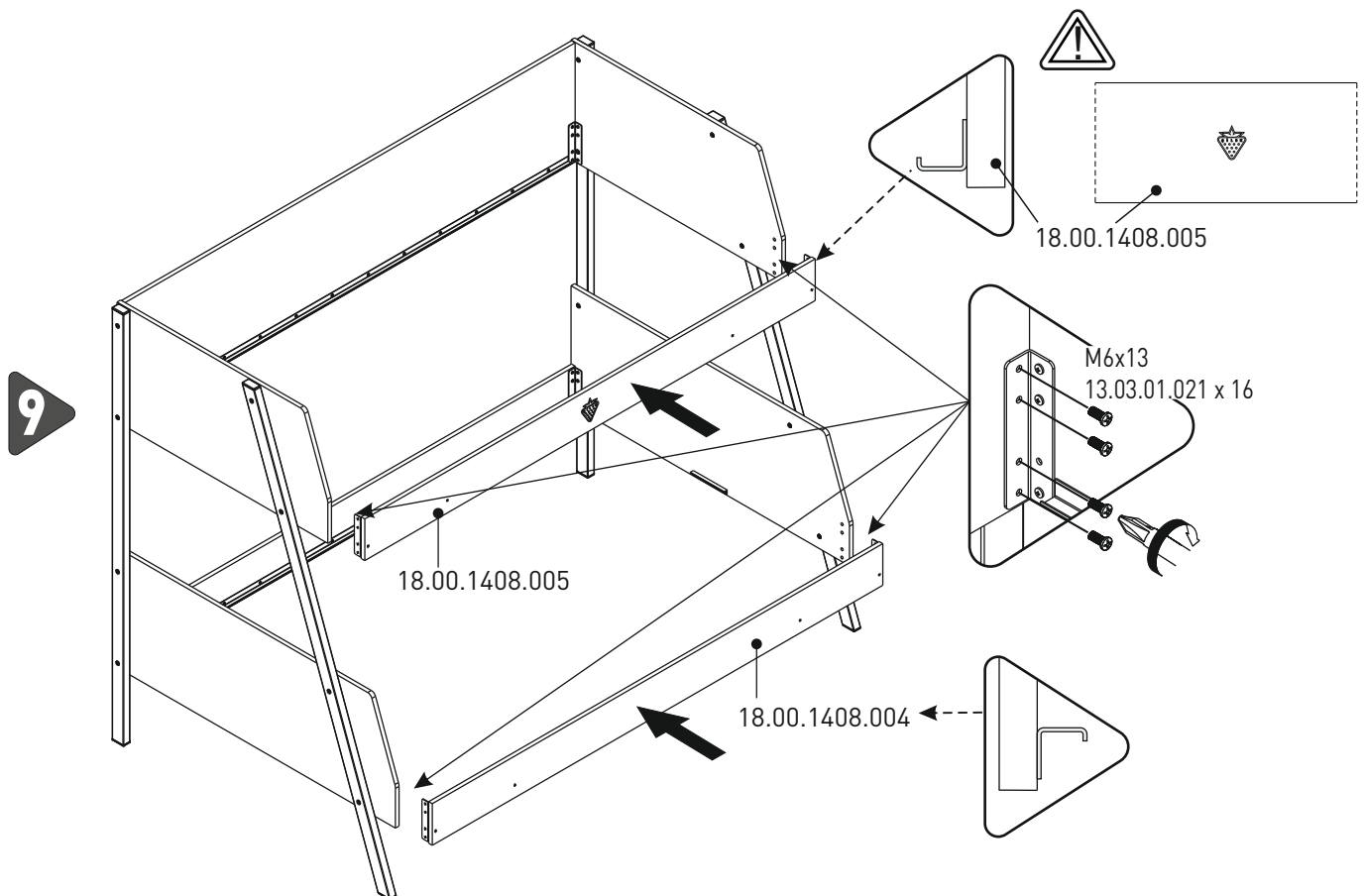
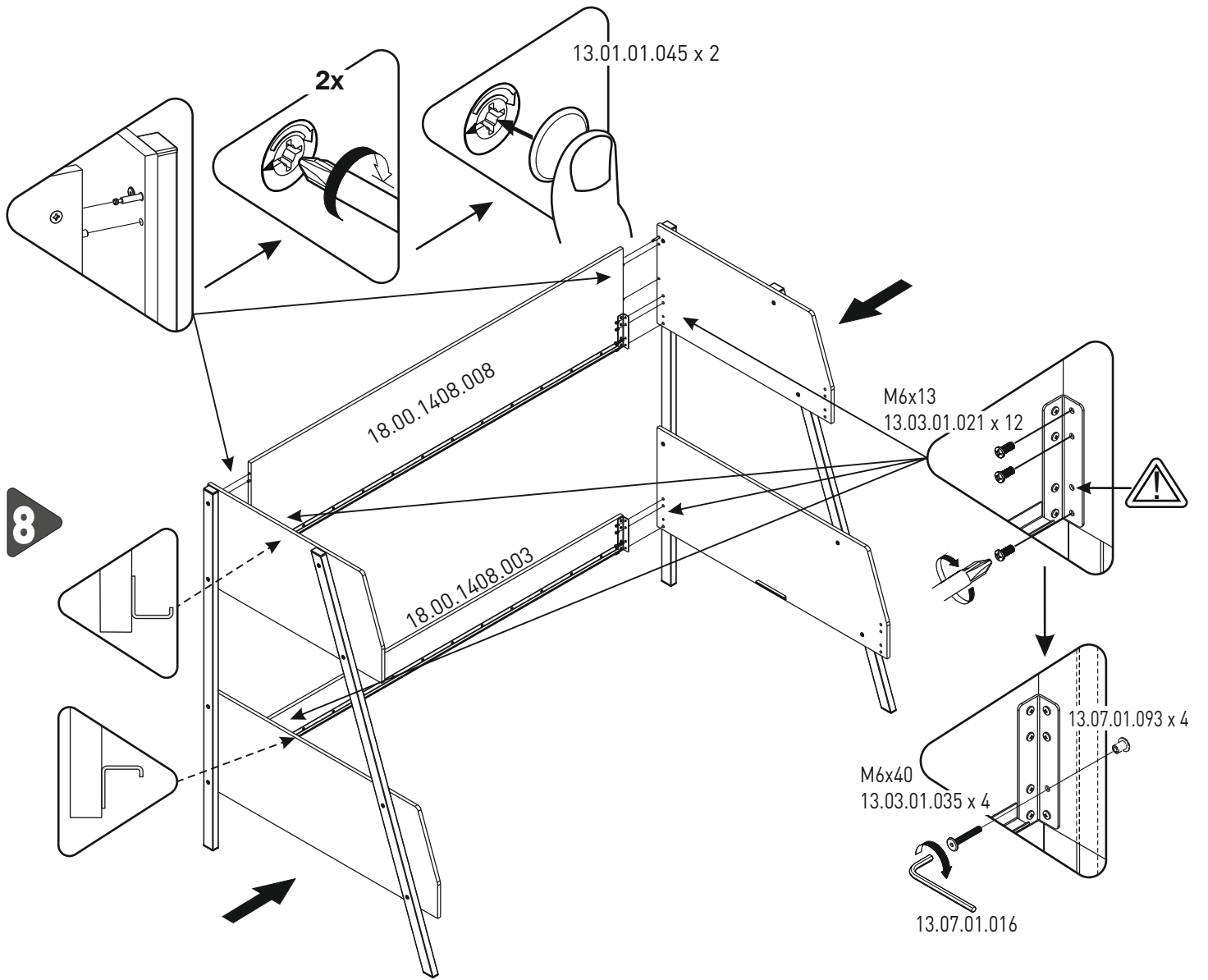

10

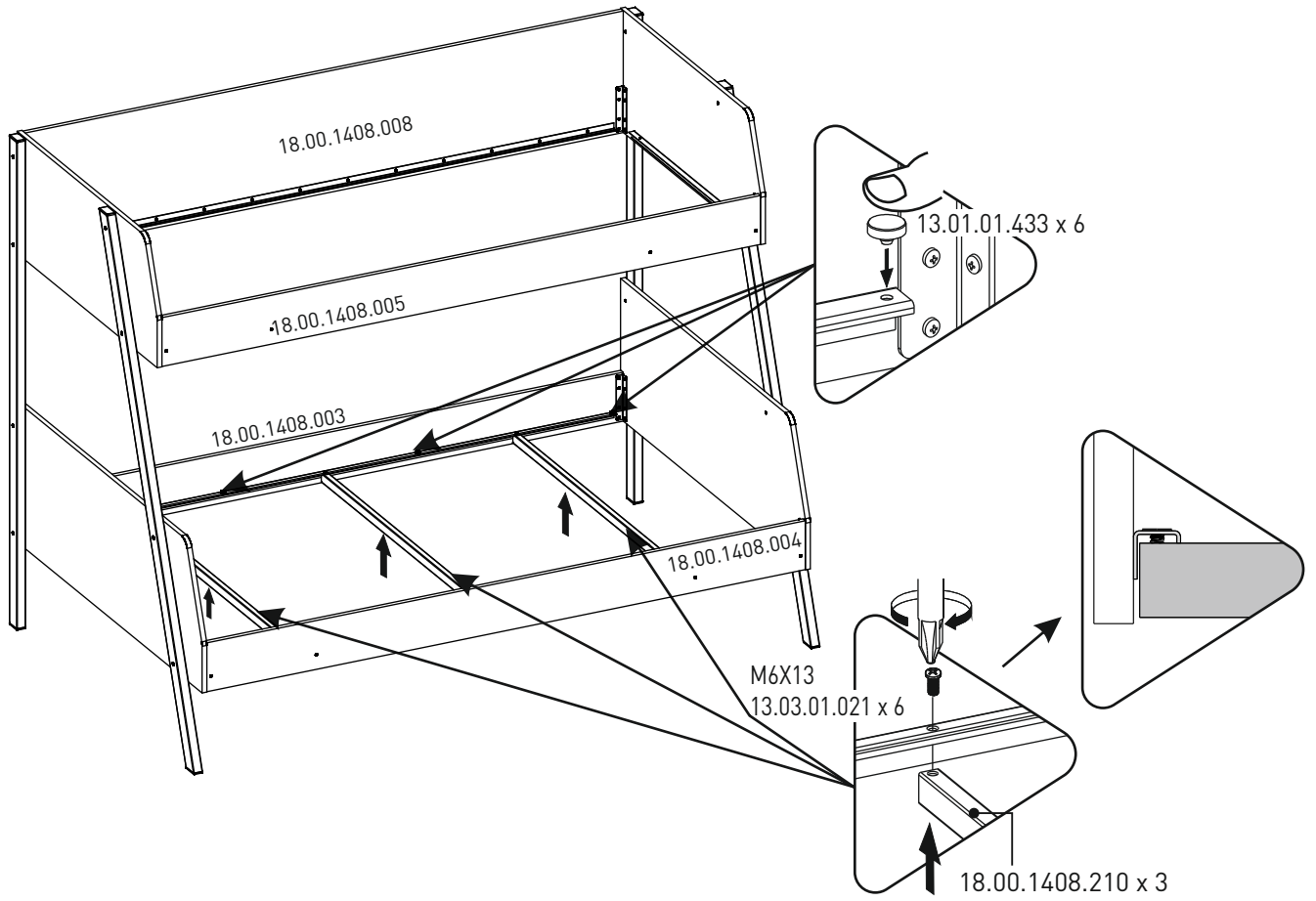

11

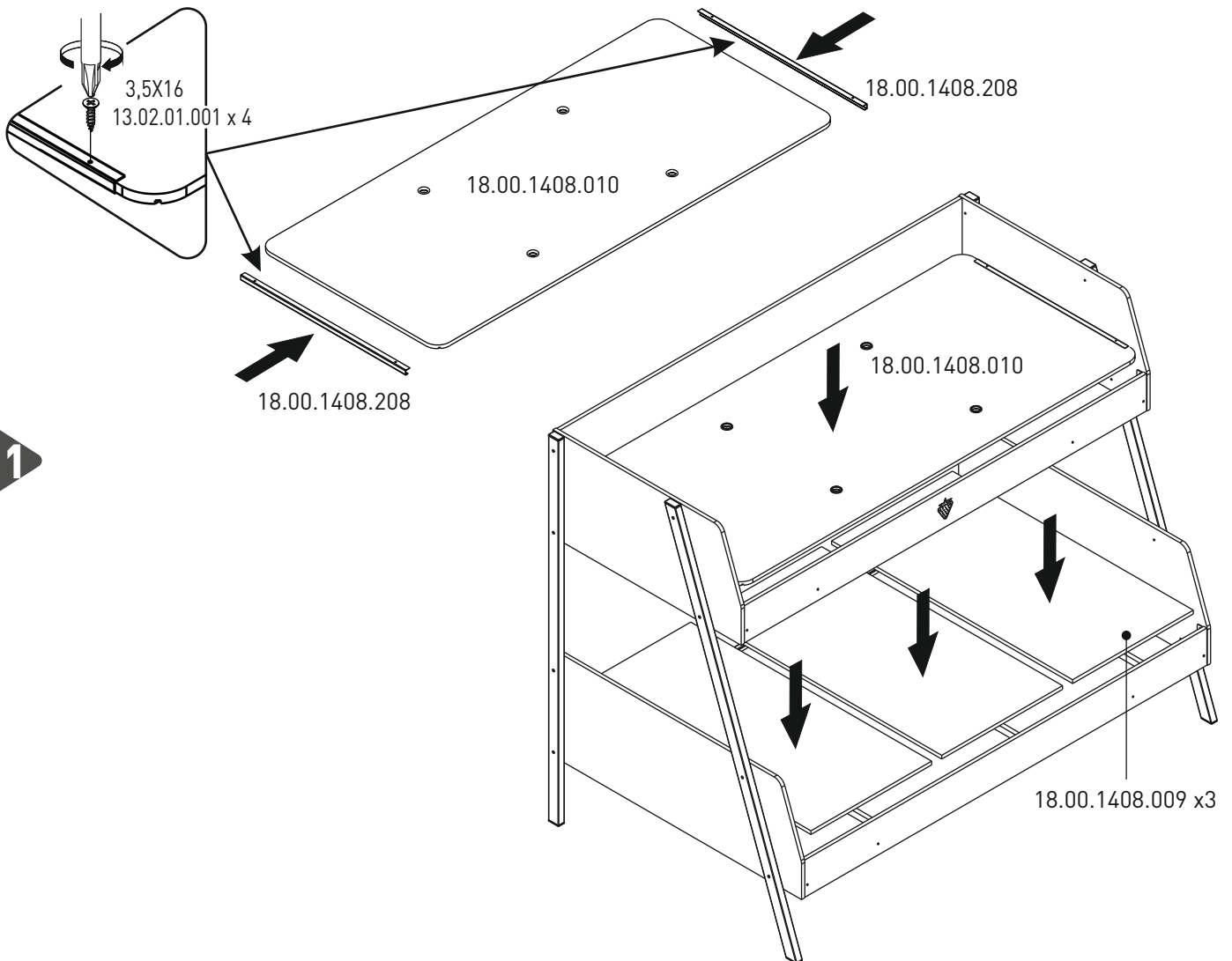

12a

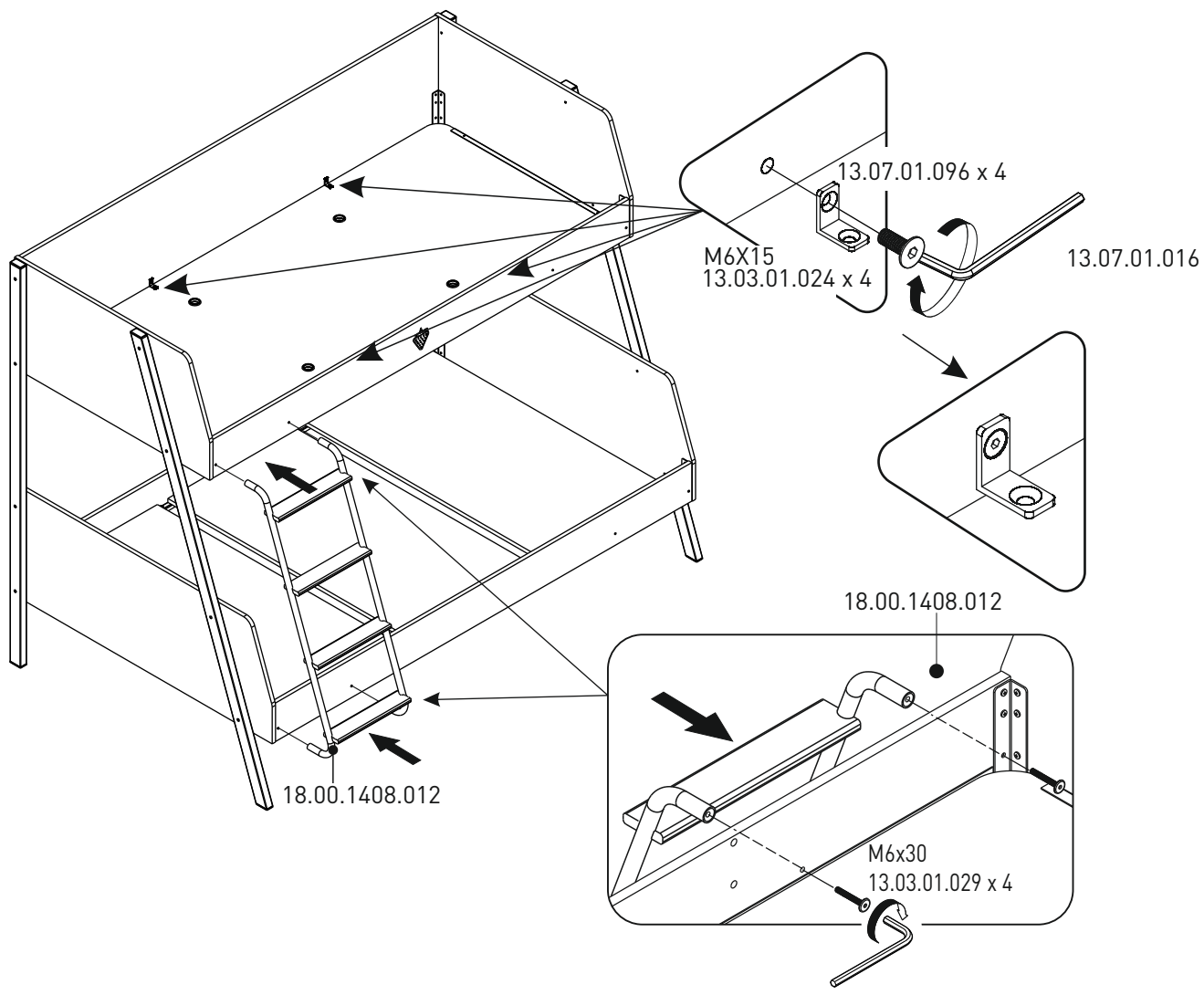

12b

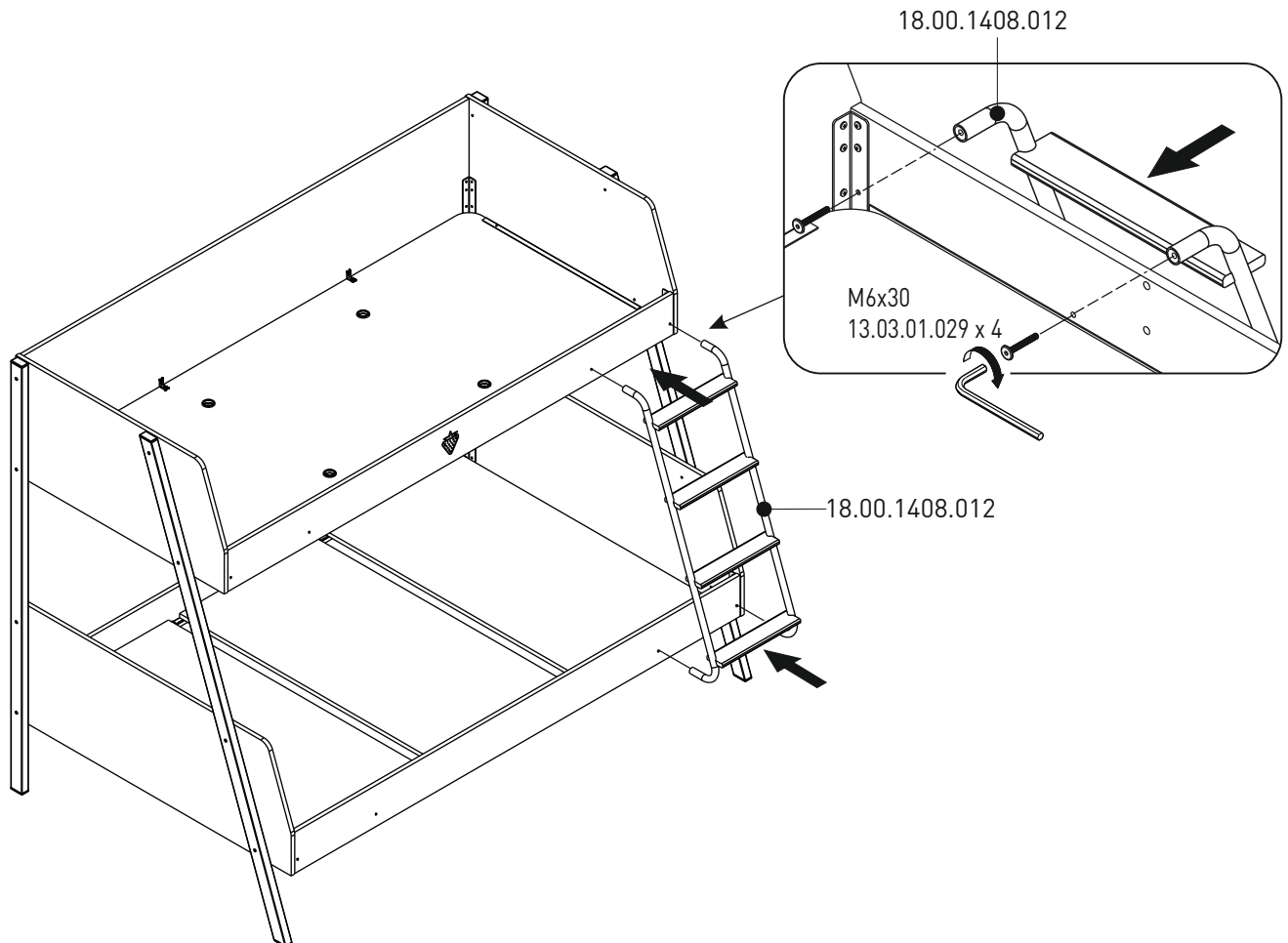



13a

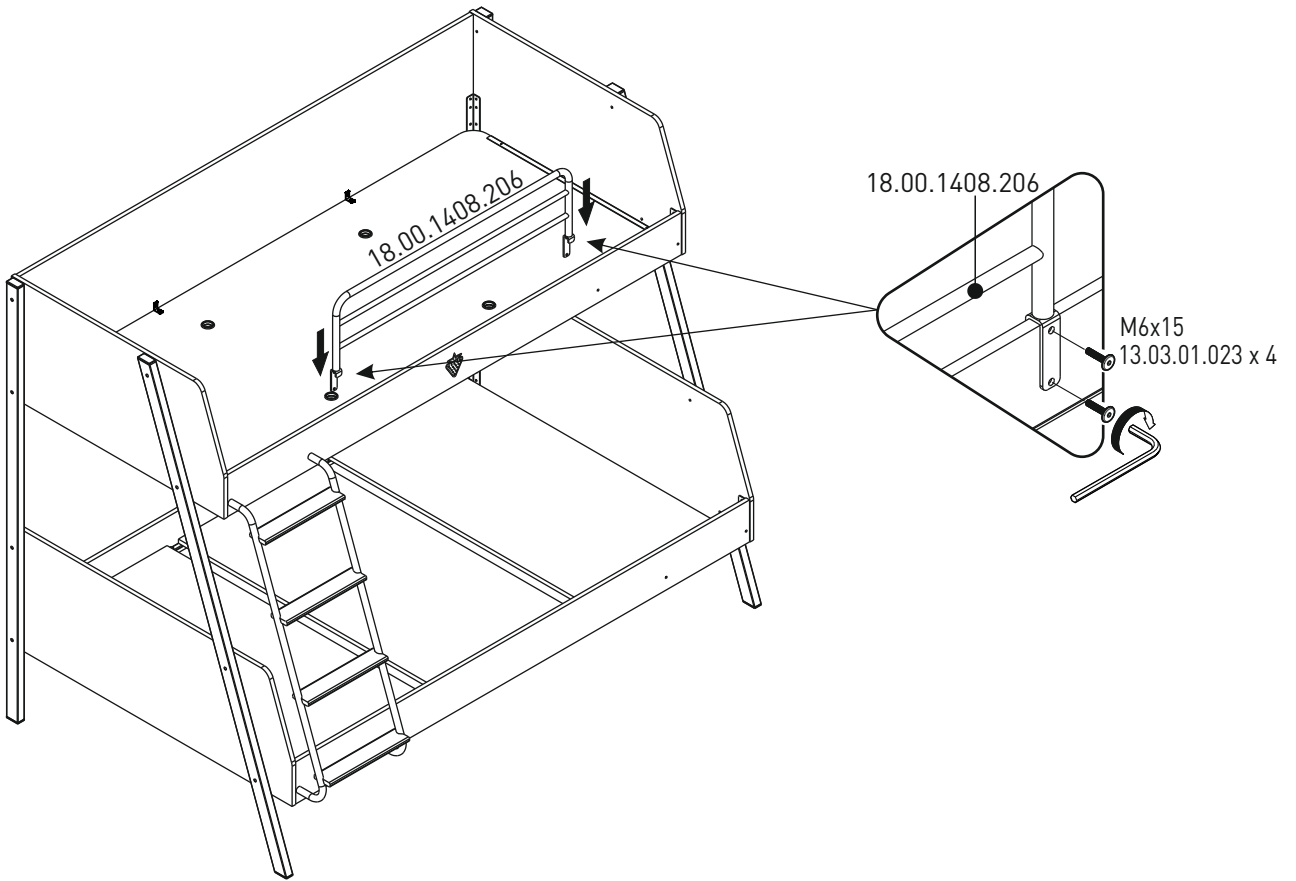

13b

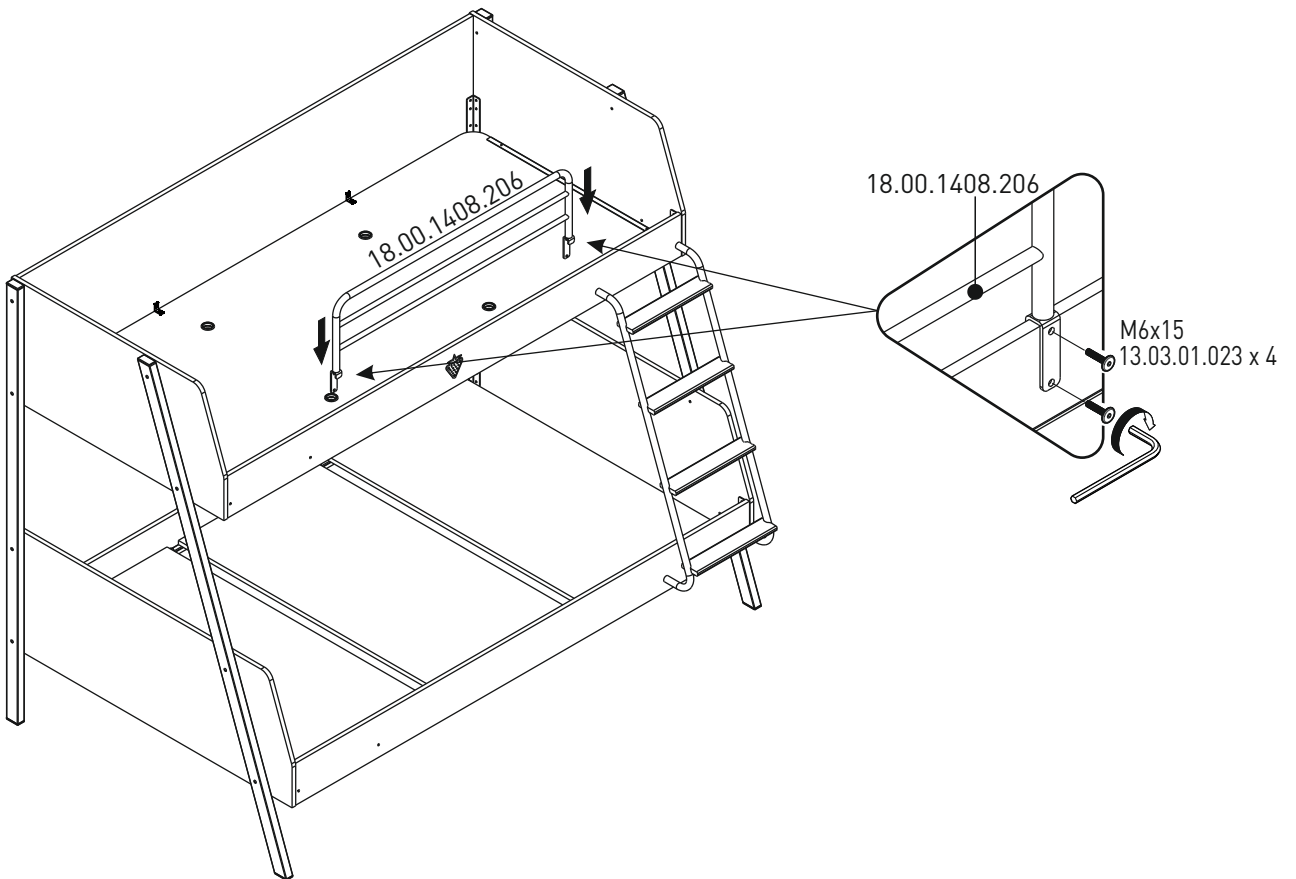

14a

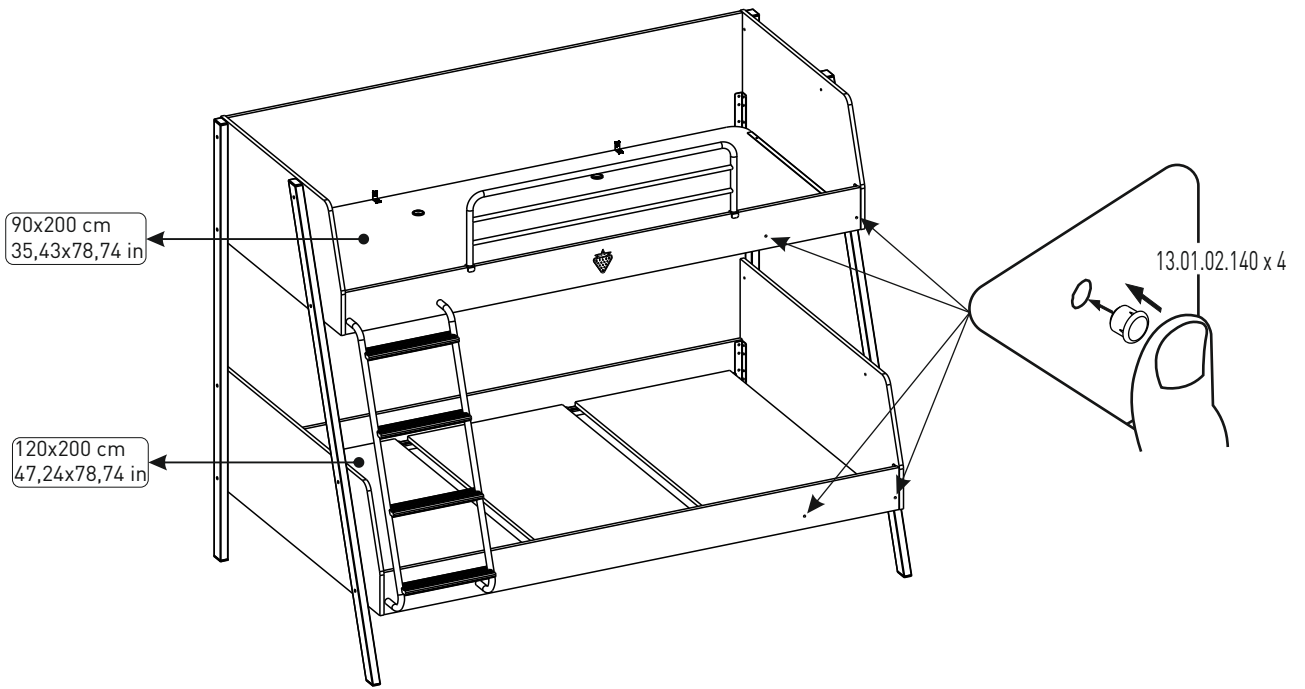

14b

