

# 20.78.1901.00

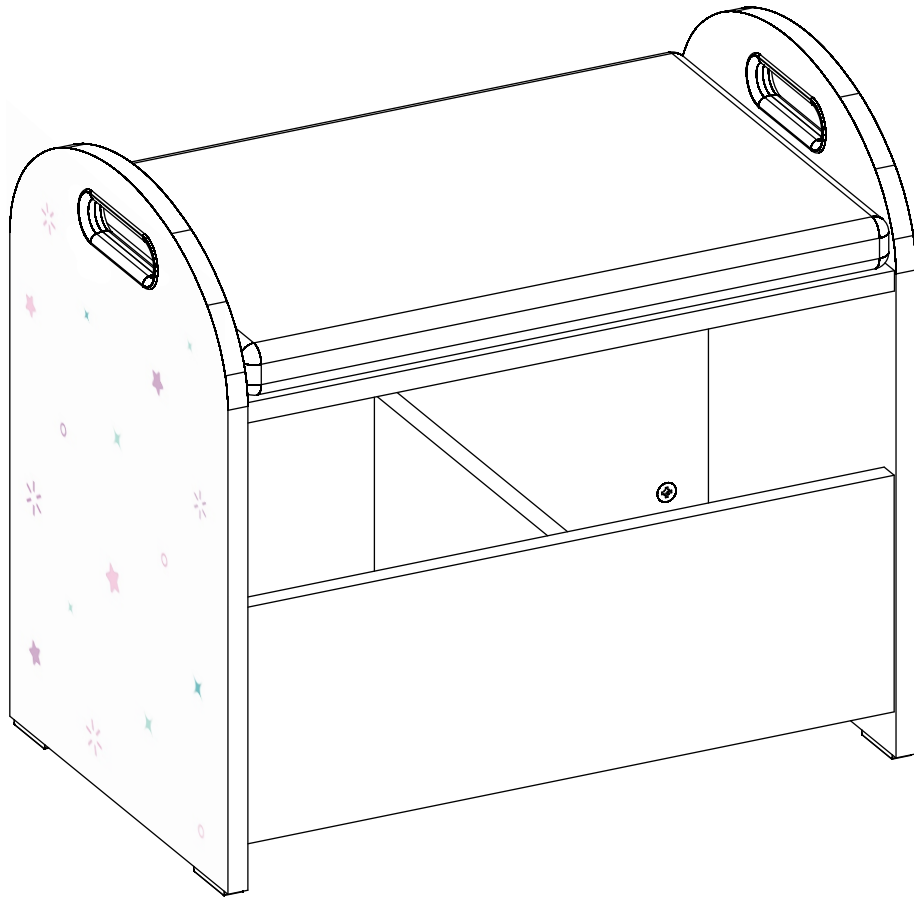

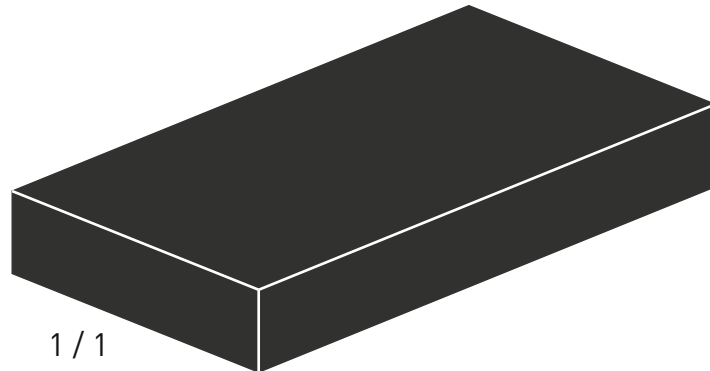

1 / 1

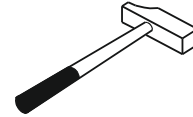
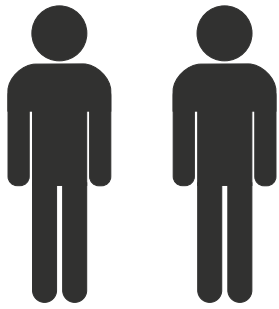
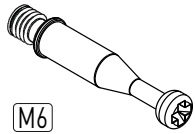

M6  
13.07.01.108 x 12



13.07.01.110 x 12



13.01.01.830 x 12

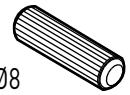

Ø8  
13.01.01.111 x 10



13.01.01.829 x 1

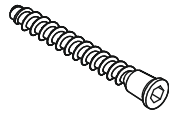

13.02.01.019 x 1



13.07.01.016 x 1

1 / 1

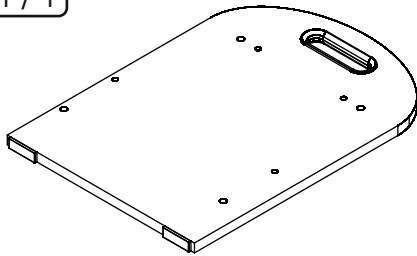

18.78.1901.001 x 1

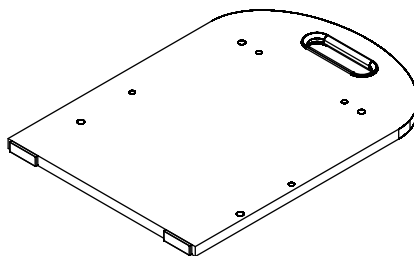

18.78.1901.002 x 1

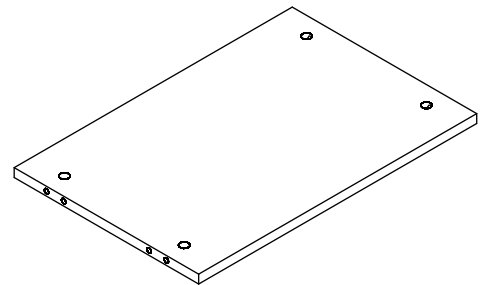

18.78.1901.003 x 1

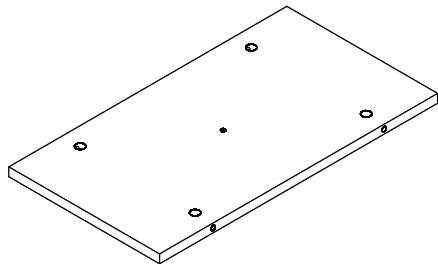

18.78.1901.004 x 1

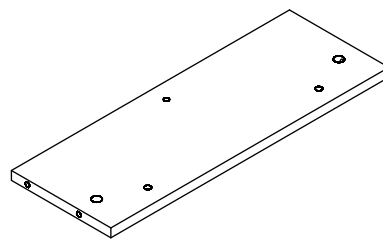

18.78.1901.005 x 2

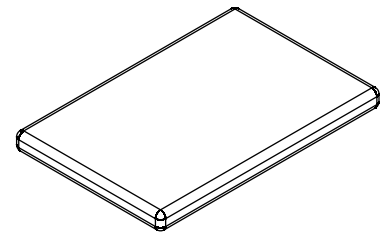

13.10.01.310 x 1

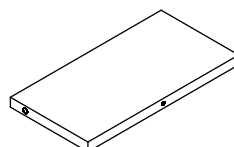

18.78.1901.007 x 1

1

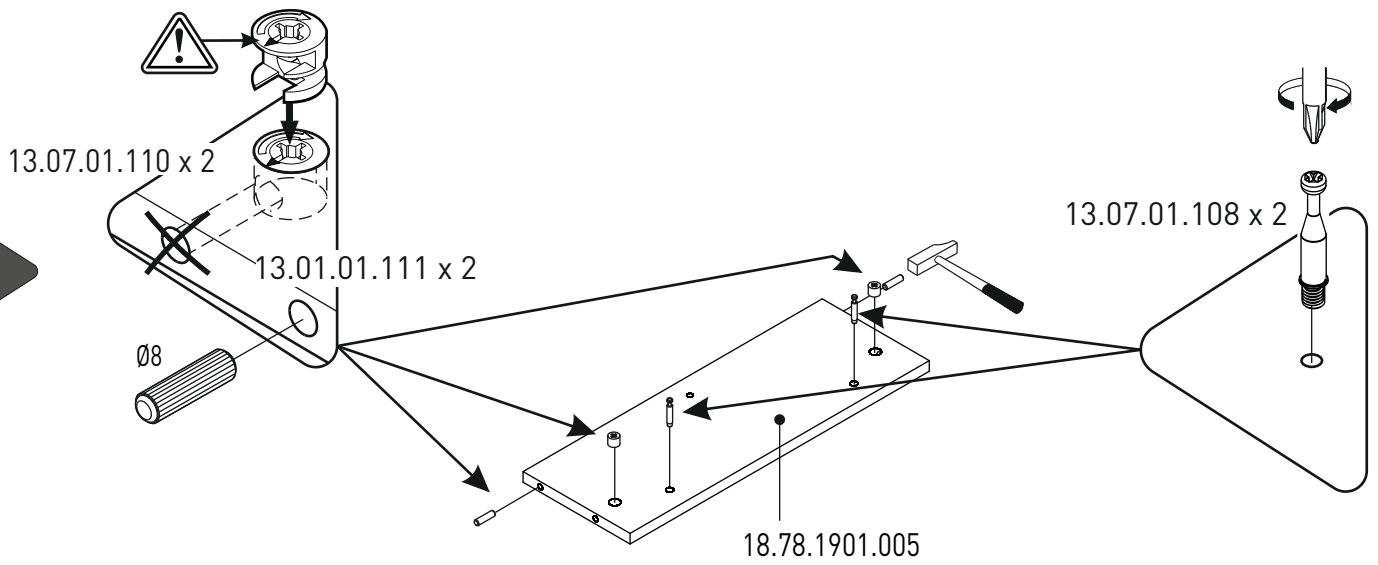

2

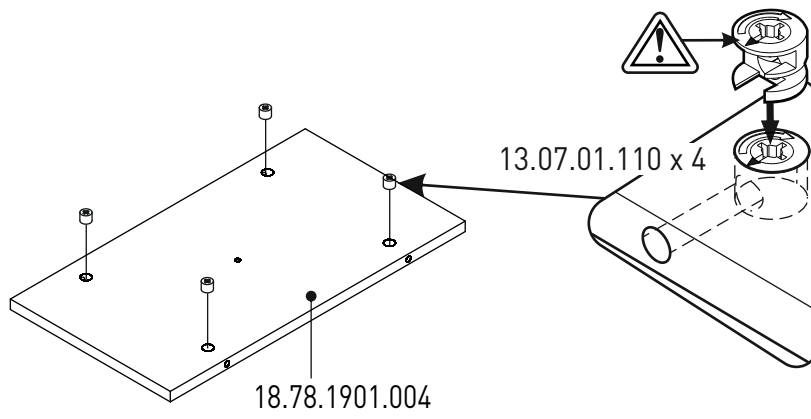

3

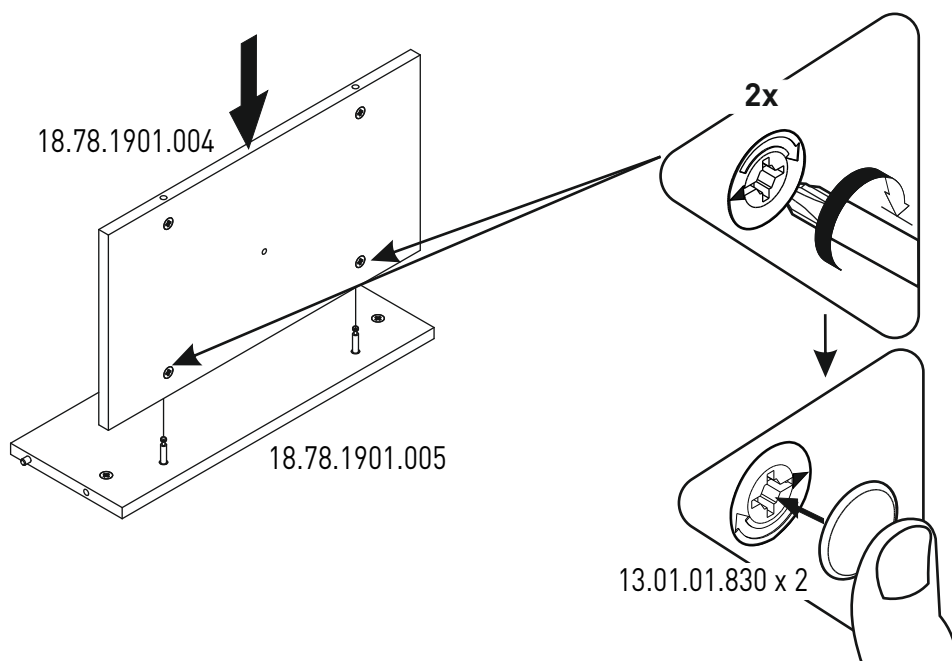

4

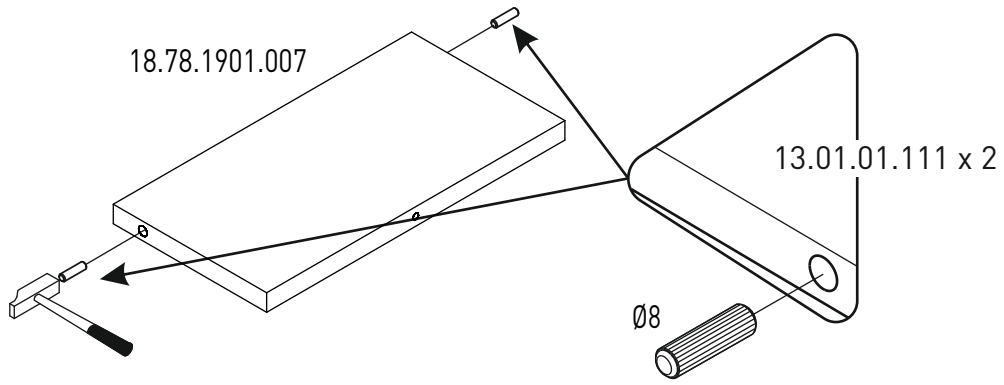

5

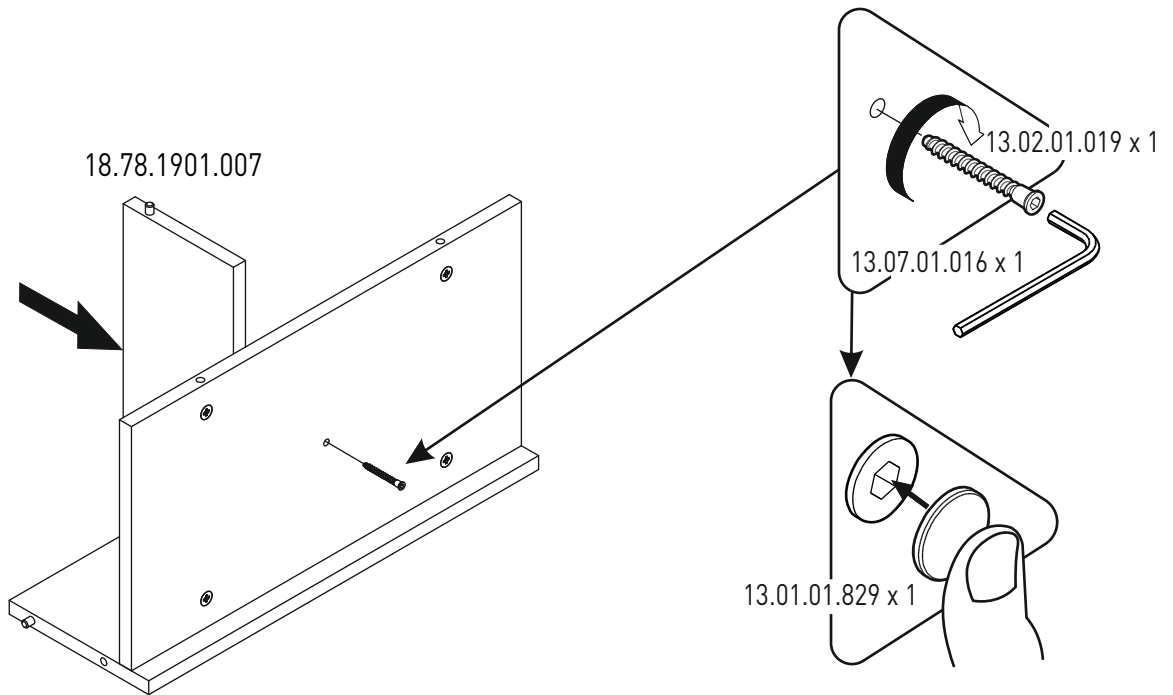

6

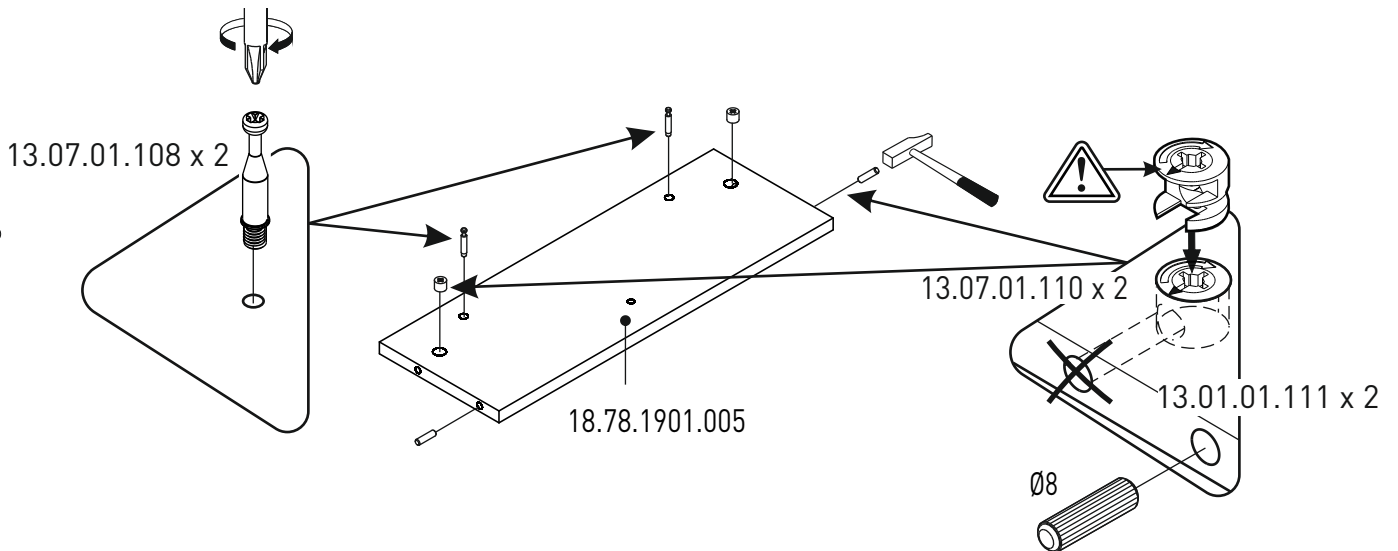

7

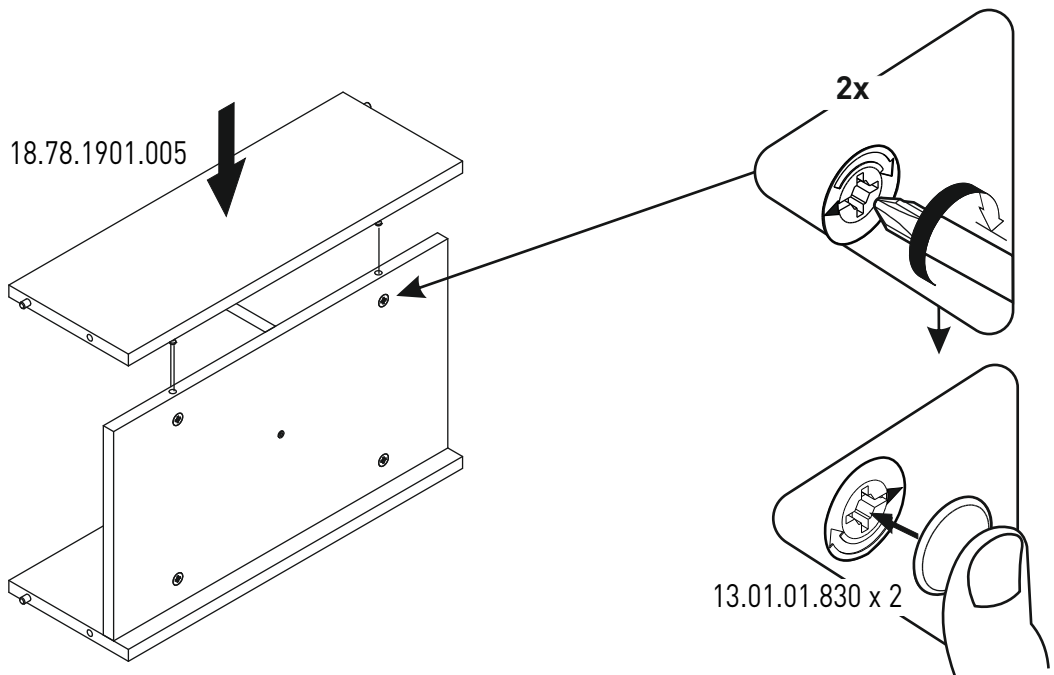

8

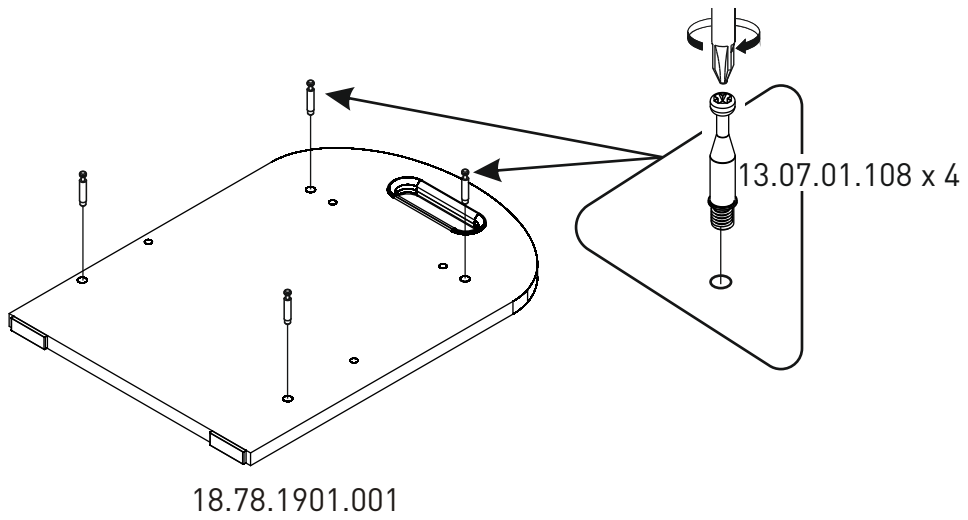

9

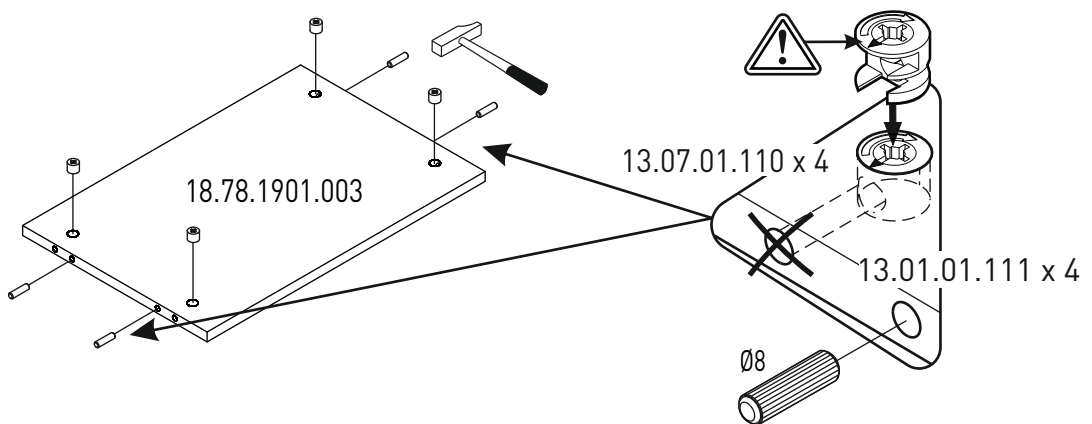

10

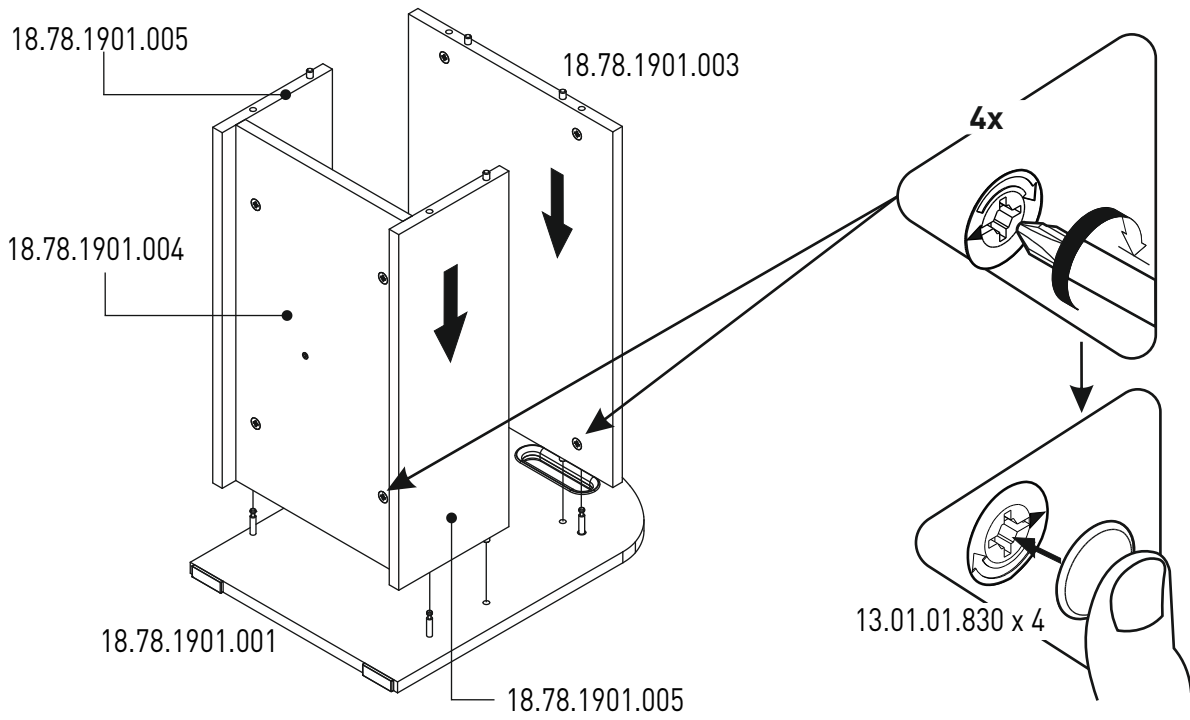

11

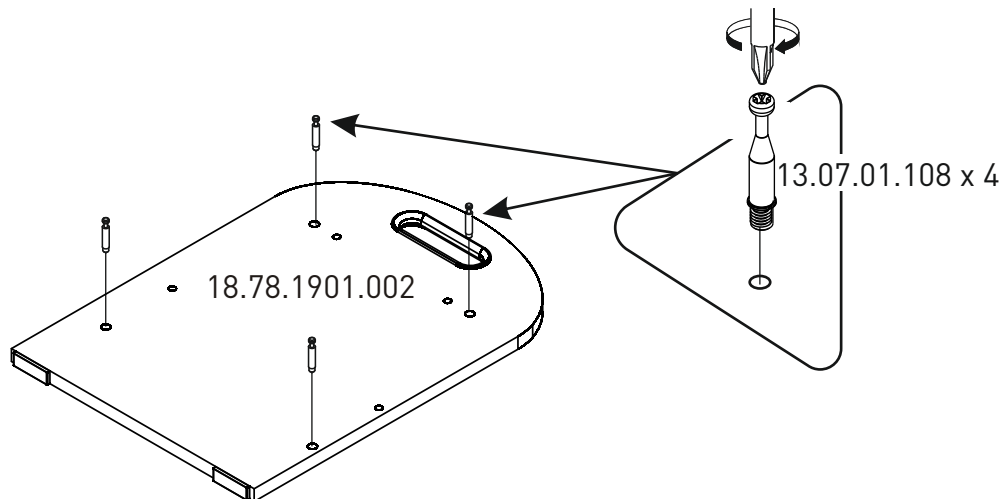

12

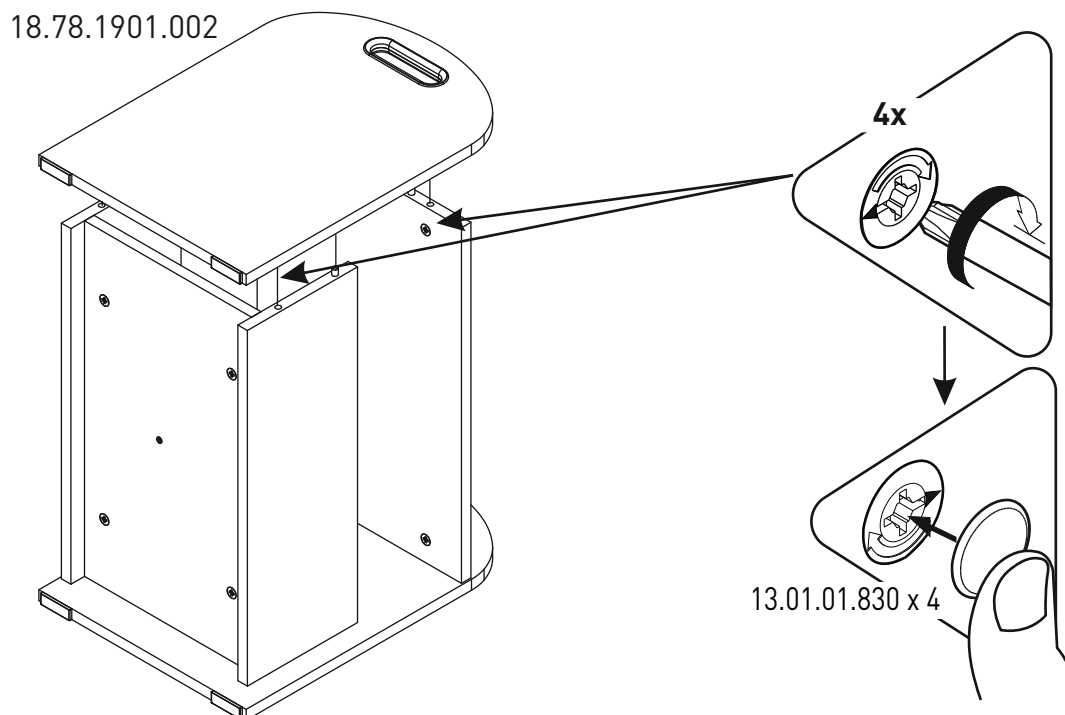

13

