

MDI. BD. AV. 1

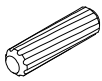

A x8
Spec: $\varnothing 8 \times 30$

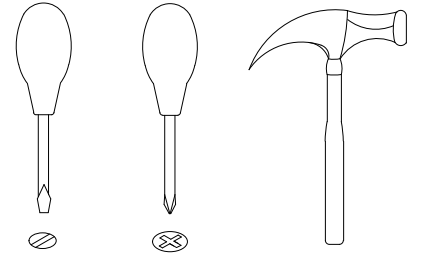
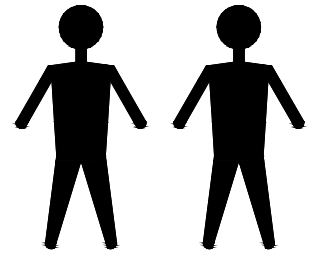

B x4
Spec: $M8 \times L85$

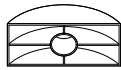

C x4
Spec:



E x4
Spec: $M8$



F x4
Spec: $\varnothing 38$

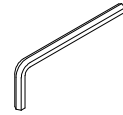

G x1
Spec: $5\#$



H x1
Spec: $14\#$

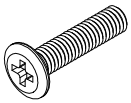

I x16
Spec: $M6 \times 45$



J x24
Spec: $\varnothing 8 \times \varnothing 18$



K x8
Spec: $L255$

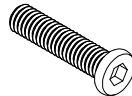

L x8
Spec: $5/16 \times L60$



M x7
Spec: $\varnothing 8 \times \varnothing 14$

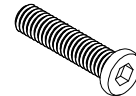

N x7
Spec: $5/16 \times L65$

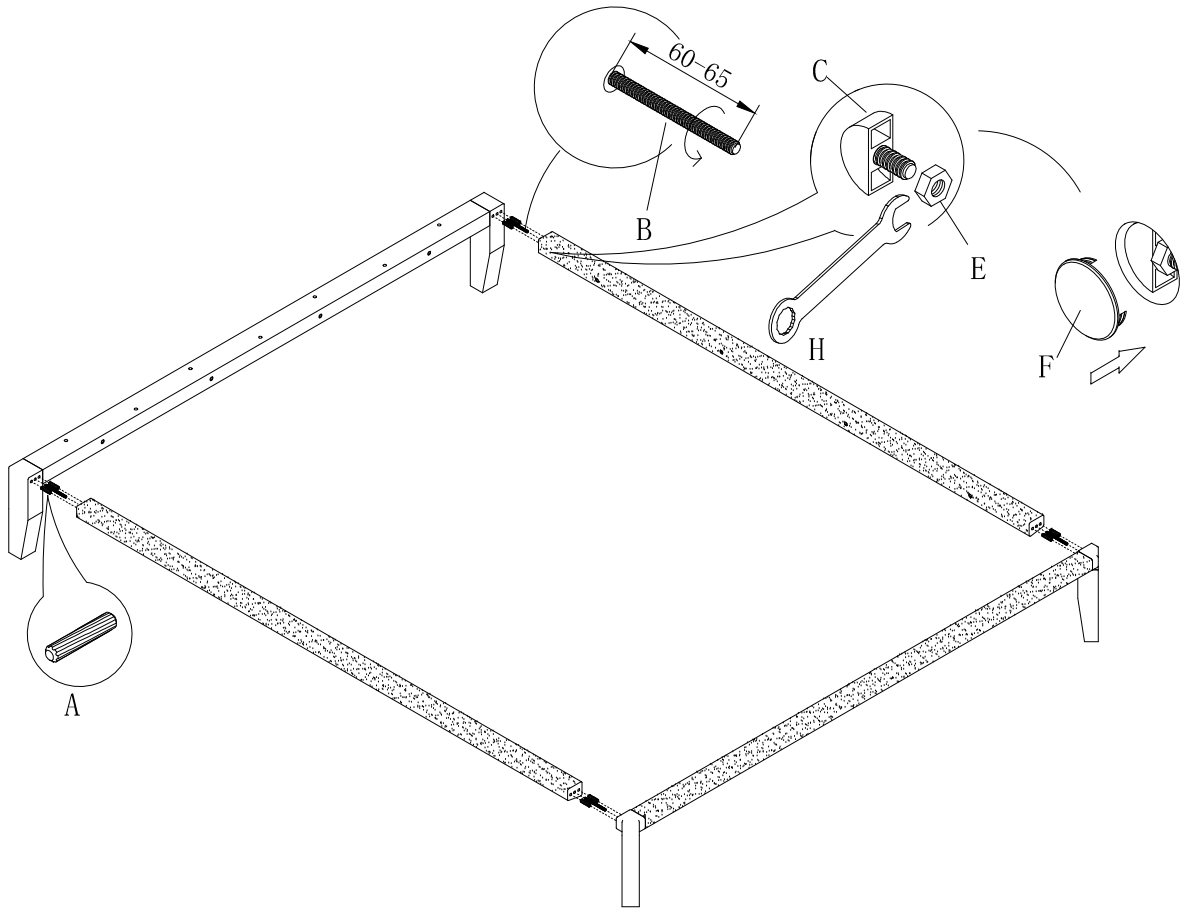

1

2

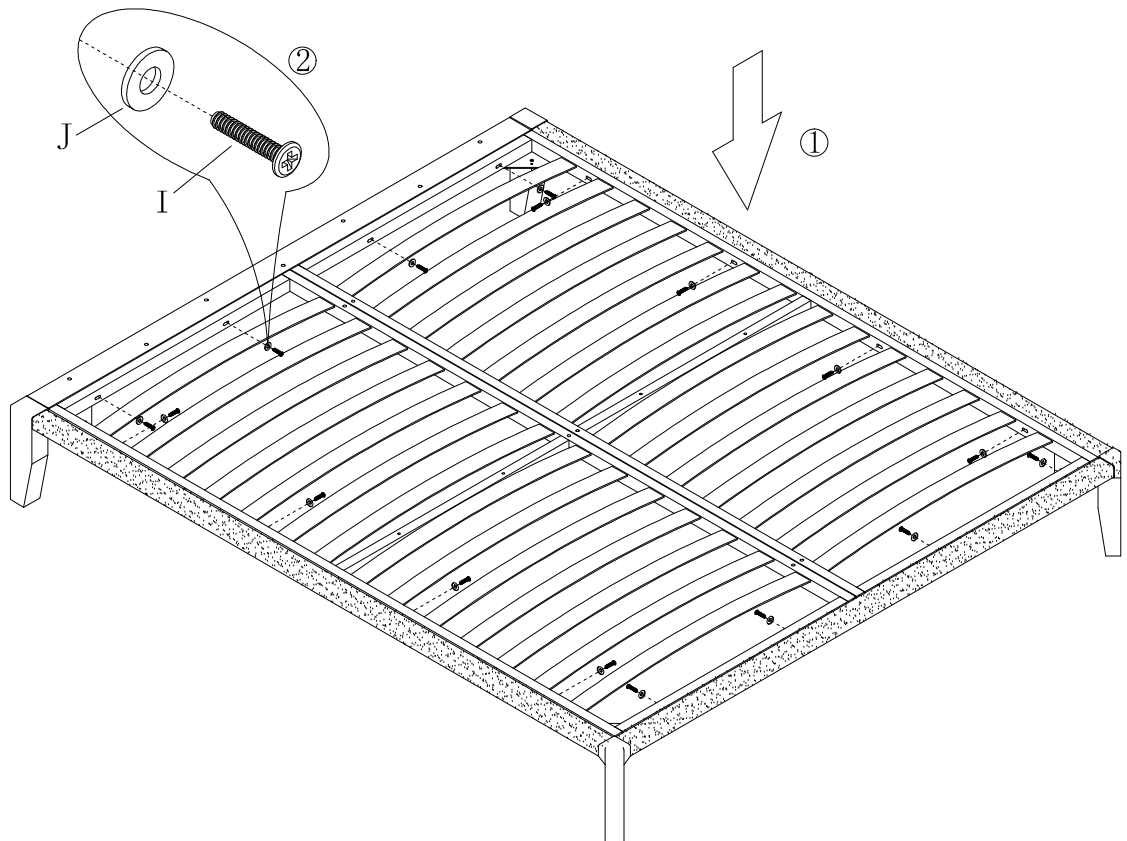

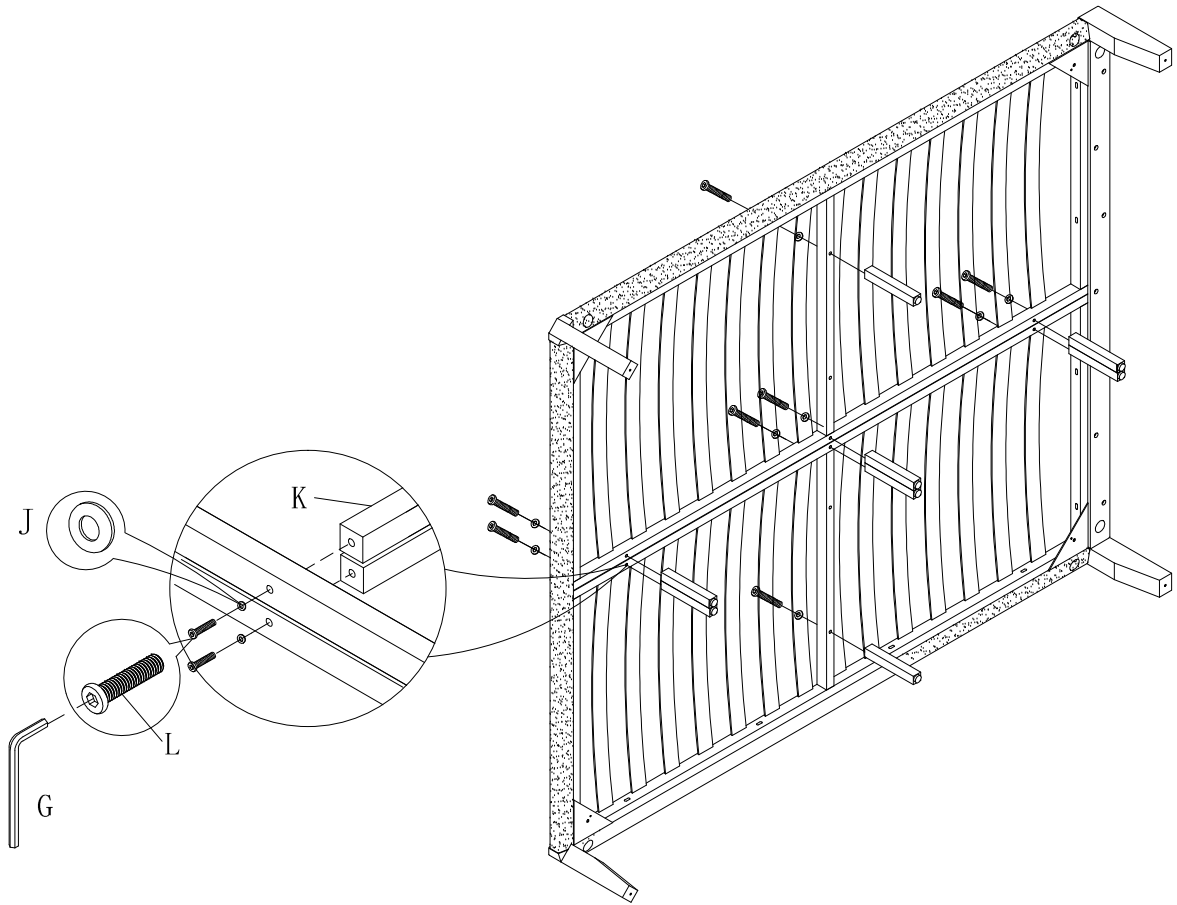

3

4

