

20.70.1303.00

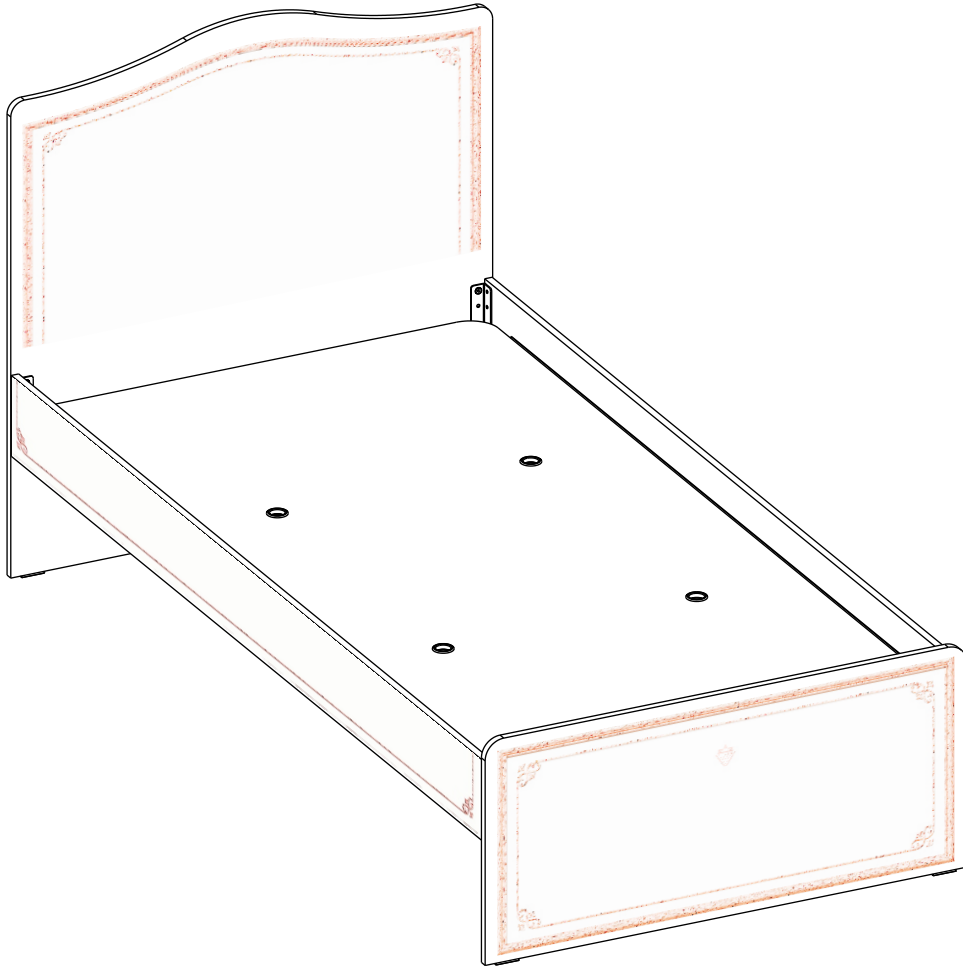

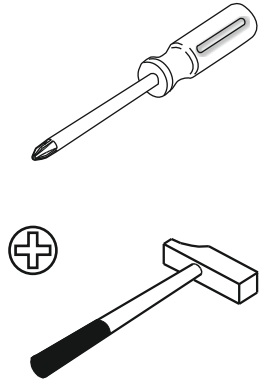
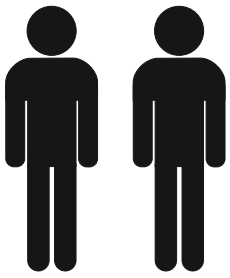

1 / 2

2 / 2

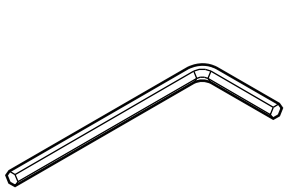

13.07.01.016 x 1

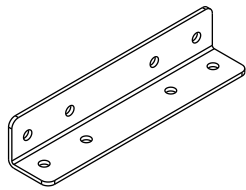

13.07.01.399 x 2

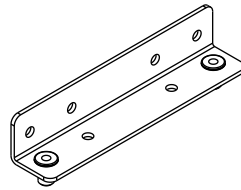

13.07.01.398 x 2

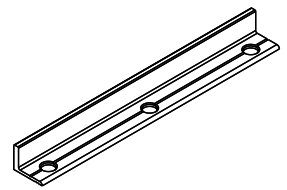

18.00.2000.208 x 2



13.03.01.021 x 28

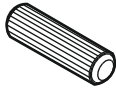

13.01.01.111 x 8



13.02.01.017 x 30



13.03.01.023 x 4
M6x15

1 / 2

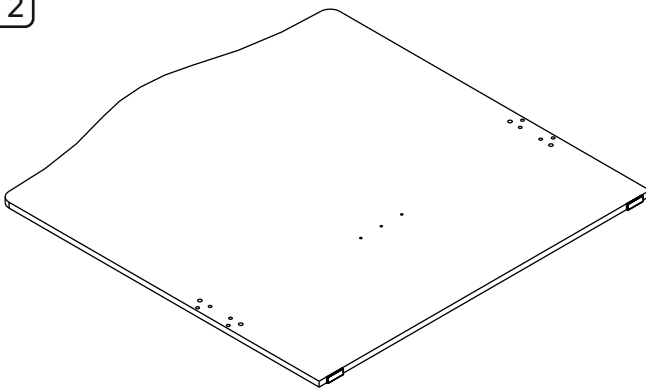

18.70.1303.001 x 1

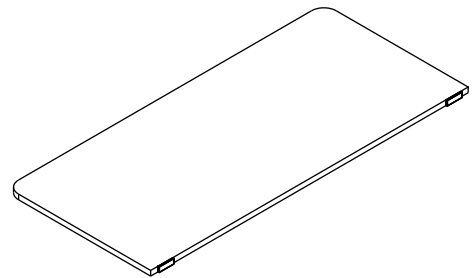

18.70.1303.002 x 1

2 / 2

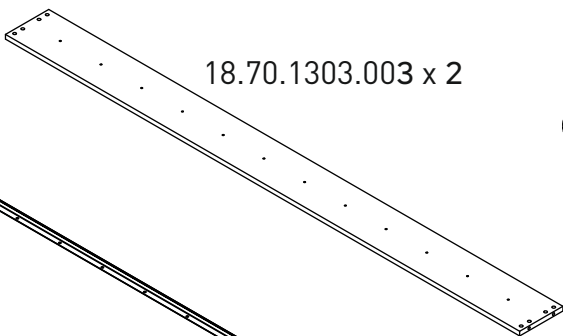

18.70.1303.003 x 2

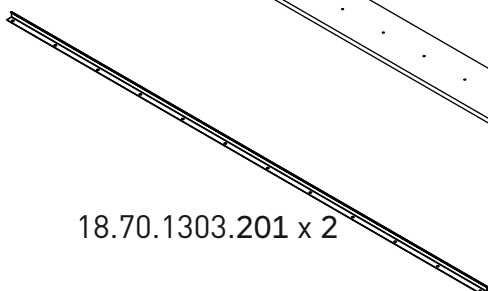

18.70.1303.201 x 2

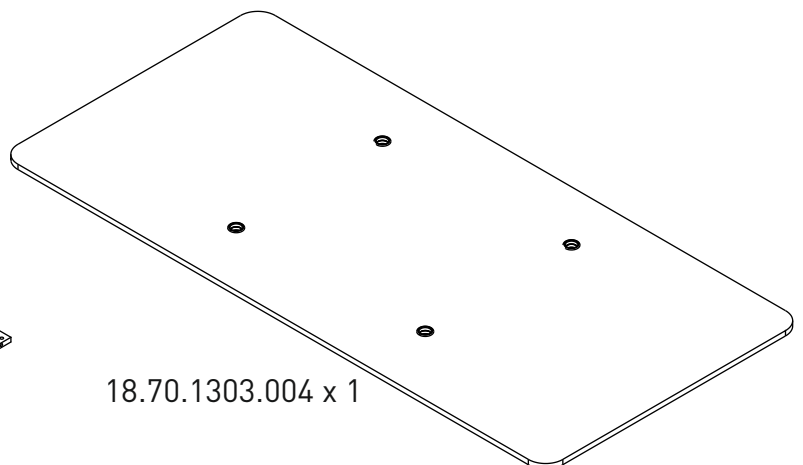

18.70.1303.004 x 1

1

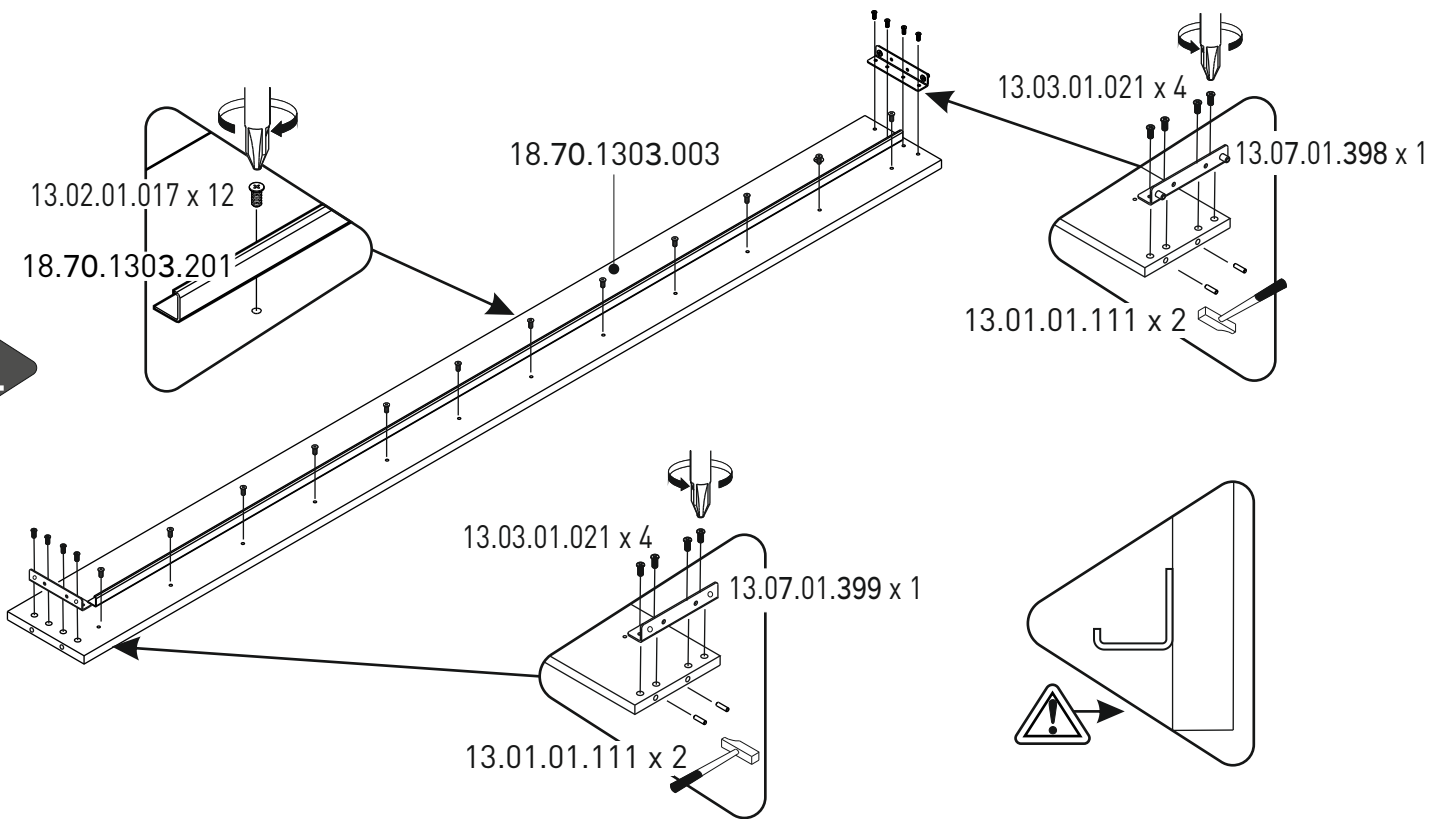

2

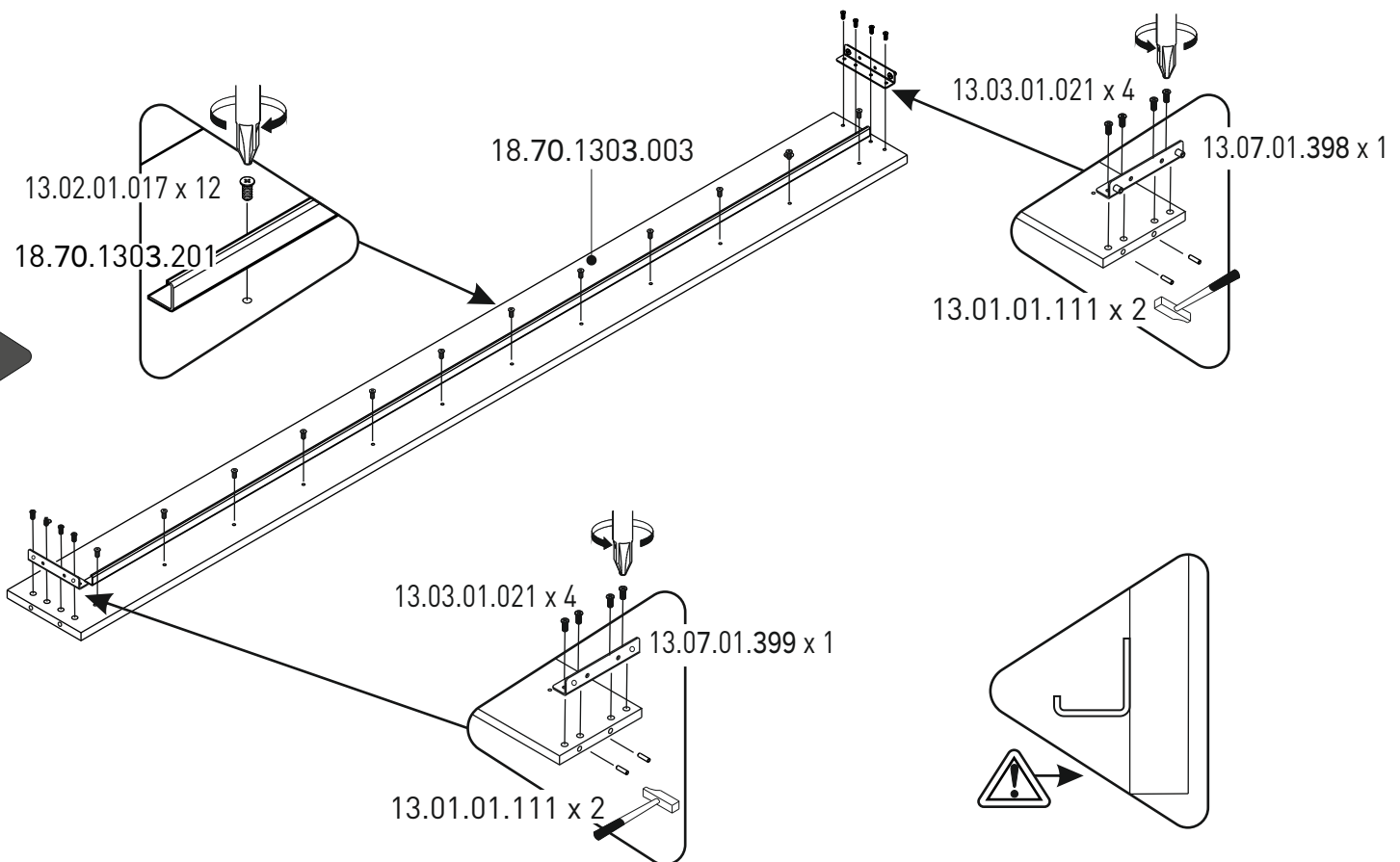

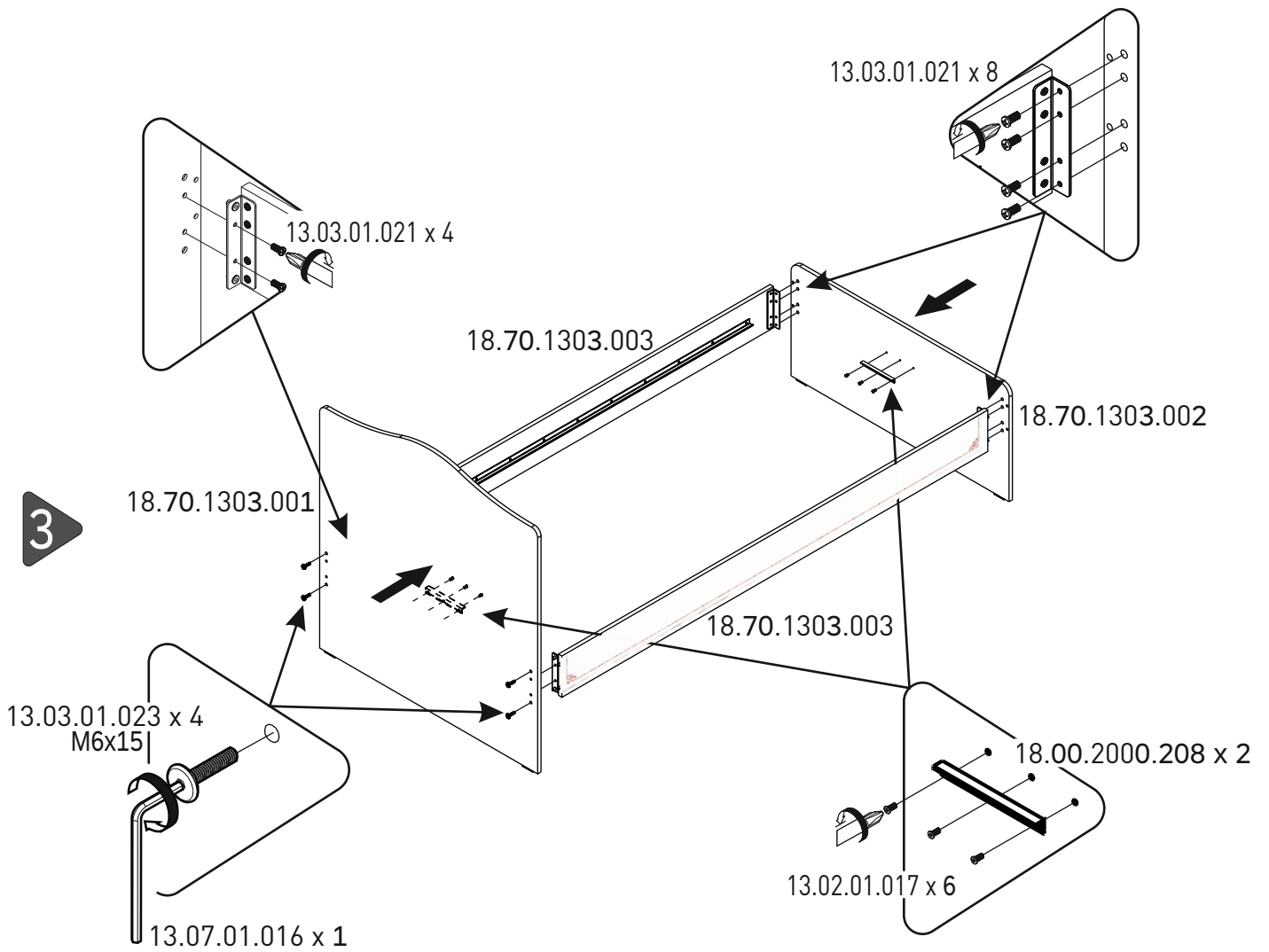

4

